

# **DROWN** **RADIO-VISION**

and

## **HOMO-VIBRA RAY** **Instruments**

and their uses

*Radionic Rate Book*

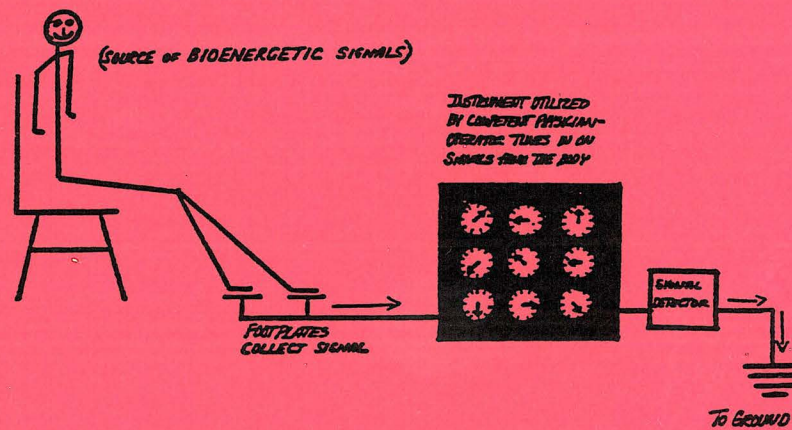

A Publication of:



P.O. Box 220 ★ Bayside, California ★ 95524 USA

This book is sold for research and historical purposes only.

DISCLAIMER: This book is sold for research and historical purposes only. No medical claims are made or implied by the publisher.

THE DROWN RADIO-VISION and HOMO-VIBRA RAY INSTRUMENTS  
And Their Use

TABLE OF CONTENTS

Part A:

The Drown Radio Therapy Methods. . . . .	1 - 3
Pictures. . . . .	4 - 5
Modified Drown Circuit. . . . .	6
Patent Specifications (Radio-Vision Inst.) . . . . .	8 - 13
Drawings. . . . .	14 - 17
The "Voice-Print" As Specimen For Analysis . . . . .	18
Bio-Vibronic Analysis Case Record Chart. . . . .	19 - 20
Diagnosing With Atomic Rates . . . . .	21 - 24
Activity Centers in Base of Brain. . . . .	25

Part B:

Technic of the Homo-Vibra Ray Instrument . . . . .	1 - 7C
Picture of Radio-Vision Instrument. . . . .	7C
Atlas of Rates . . . . .	8 - 83
Endocrine Glands. . . . .	8 - 9
General Diseases. . . . .	10 - 14
Diseases and Their Causes . . . . .	15 - 17
Discharges. . . . .	17 - 18
Pain. . . . .	18 - 43
Tenderness. . . . .	43 - 67
Vertigo . . . . .	68
Differential Blood Count. . . . .	68 - 70
Bones . . . . .	70 - 72
Circulation . . . . .	72 - 74
Miscellaneous . . . . .	74 - 83

PART C:

Some General Observations and Instructions . . . . .	84 - 96
Index. . . . .	I - XXX





Ruth B. Drown



## PART A

### THE DROWN RADIO THERAPY METHODS

By Dr. Ruth Drown

From the Round Robin Journal of  
Borderland Research, Sept-Oct 1951.

The energy used in diagnosing, treating and photographing soft tissue is that of the patient, with no auxiliary current present. That used in the photographic instrument is also the energy of the patient, plus a 9-volt battery to start the flow of electrons through the photoelectric tube for not more than a minute, which lasts for several pictures before renewal. The principle underlying the work is simply that everything in the universe vibrates, and also has polarity. The energy which animates the human body is the same as that which is withdrawn at death, and is also that which, when coupled with the energy of the earth, produces metabolism of the cell structure. This fact furnishes the foundation from which to describe the rest of the work.

This energy comes to man in a perfect state, but by reason of his thinking apparatus it becomes obstructed in some part of his body, and we call the result disease. Even accidents are attributable to the thinking apparatus; for are they not the result of "lack of thinking"?

Every part of the body, human or animal, vibrates differently from every other part when animated by the life force. When the ruling energy passes through each organ, gland or tissue, it goes out from the body and around the world at enormous speed. According to the Ancients it traveled at the rate of 345,000 miles per second, whereas ordinary light has a speed of 186,000 miles per second. This energy is passing from and returning to the body at all times; for all energy returns to its source.

When a drop of blood is received at the Drown laboratories it is put on a blotter to hold together the fine crystals of salt and other minerals, which in turn act in the same manner as the small galena crystals acted in the old crystal radio sets. These crystals are always in resonance with the energy of the body from whence they came. When placed in the Drown instrument, the energy (life force) of the patient is drawn through the instrument; and by proper tuning it is possible to diagnose,

or treat, or make a picture of the part of this body which sent it out.

The "rates of vibration" were originally worked out from histological structures of the animal body. A liver, for instance, is always recognizable as such, even though it be taken from a cat or dog; but the difference lies in the different rate of vibration of the animating energy. The disease rates were taken from specimens found and labeled in medical hospitals. These also have their own rates of vibrations which are "tuned" through the Drown instrument. When these rates are found and placed upon the photographic instrument, it is possible to photograph the cell structure of the part involved, whether the patient is in the same room or at a great distance, since his energy is where the picture is being taken.

The Drown instrument is only a tuning-board, used to resist and focus the patient's energy under treatment. In this way the patient heals himself, though under the direction of the doctor after the condition which is out of balance is ascertained.

In these times when everything is being speeded up and energies are being sent into the Etheric, bombarding the brain and body structure with sounds and forces hitherto unknown, it is necessary for the human body to be speeded up also, or else be shattered. The Drown method helps to do this in a natural way. Hemorrhage control is also a part of the treatment method. This is done by treating the parathyroids, which control hemorrhage in any part of the body.

#### FURTHER COMMENT ON DR. DROWN'S WORK (From Jan-Feb and March-April 1961 Journals of Borderland Research)

"The cornerstone of the diagnosis is the case history. This is made as complete as possible. Then the patient sits with his feet on the Foot Plates of German Silver, a few feet to Dr. Drown's right. Her assistant sits on her left with the diagnostic chart. Dr. Drown can in this position read the dials, talk to the patient or her assistant, as she chooses. She sets herself aside from the instrument as diagnosis is not dependent on her state of mind, ESP or psychic powers. It is the instrument that is telling the story by its reactions to her rubbing fingers on the detector plate. There is no "holding a thought", as she establishes the First Cause of the patient's difficulties, by going through more than a hundred entries on the standard chart. After about 40 minutes a complete blueprint of the patient's body has

been made. Homeopathic extracts of healthy glands and organs are used to determine First Cause.

"There are 30 of these extracts. One by one these little bottles, with their vibrations of a healthy kidney, liver, heart or whatever, are placed in the specimen well on the instrument. By a process of elimination the substances which are capable of dissipating the disease reaction on the instrument's detector pad are separated from those which do not. The final step involves setting the dials to the organs and glands which are low in function. One homeopathic substance survives these finer tunings and dissipates disease reactions. This represents the organ or gland that is the First Cause of disease.

"If the patient cannot be present for diagnosis or treatment, a blood specimen, dried on a piece of clean white blotting paper and placed in the specimen well, serves as a contact. If the patient is present, a plate of block tin, with a connecting wire leading back to the instrument, is placed over his solar plexus. On the tiny current flowing between these two dissimilar metals (the German silver footplates and the tin plate, through the instrument, are born the patient's 'molecular broadcasts', sent out from all the organs, glands and tissues.

"As a treatment device, the instrument is set at the disease rate. The patient's energy is thus focussed back into the tissue from whence it came, to produce new, healthy cells to replace the old, diseased cells. This alters the vibratory rate of the diseased organ or gland; so the doctor must periodically monitor the rate of change, to keep the treatment rate and instrument in resonance with the area being treated.

"The instrument -- especially the detector or rubbing plate -- the footplates (on which the patient places his bare feet), and the tin treatment plate, must be thoroughly de-magnetized and cleaned after diagnosis and treatment of one patient, before starting with another patient. If this is not done, the old vibes will contaminate the new, giving the doctor false readings on the new patient."

"A small bar or horseshoe magnet moved slowly around among the dials and over the footplates should suffice. The rubbing or detector plate should be cleansed with a strong astringent, such as oil of cloves. Dr. Drown used a different tin plate for each patient when giving a series of treatments."



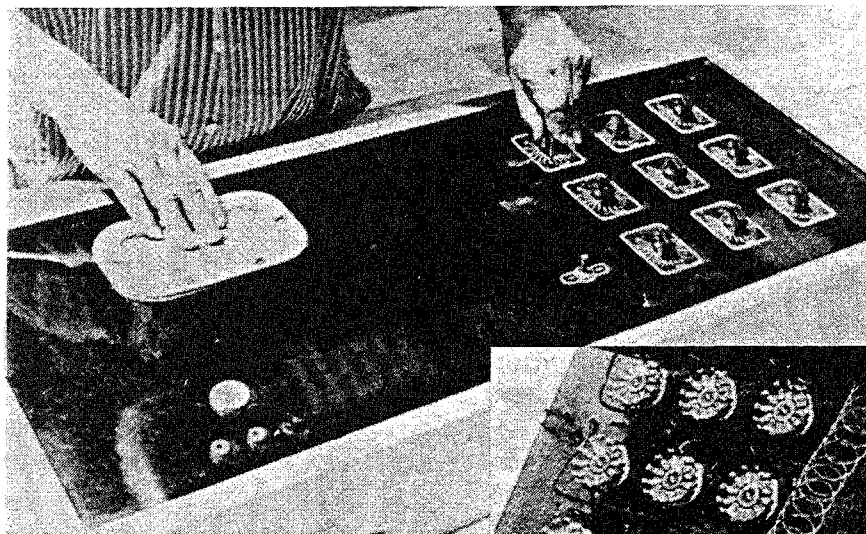

THE HOMO-VIBRA RAY INSTRUMENT of Dr. Drown's early days, designed for right-handed people. The operator's right hand is on the rubbing or detector plate, where the shtick is produced when the circuit is shorted at the finger-tip contact.

THE OPERATOR'S left hand is on Dial 9, the tuning dial, the pointer of this is set at 10 and brought down the scale until the shtick indicates the number or rate of the disease. The other dials have been set with the rate given in the Atlas.

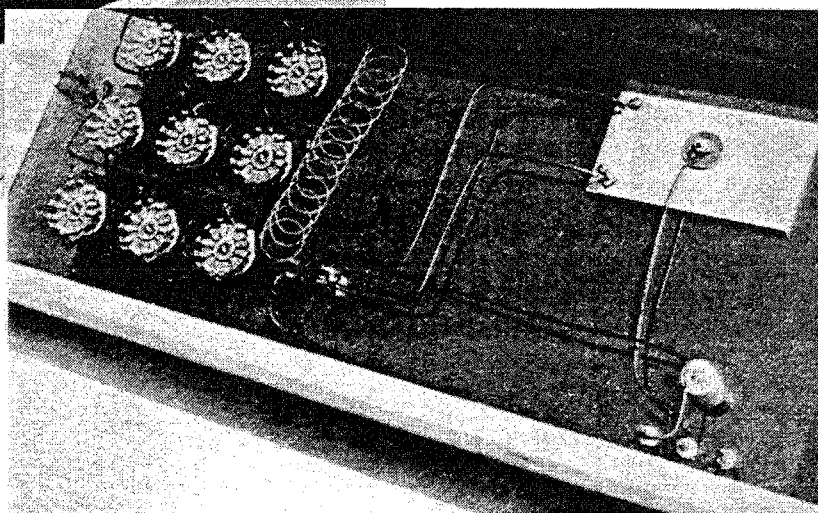

Above the rubbing plate is the Specimen Well and three contact points for wire leads from the German Silver footplates, for the Ground Wire, and for the Tin treatment plate when the machine is used for treatment. The Treatment Plate wire connects to the Specimen Well.

THE SECOND PICTURE ABOVE shows the underside of the black bakelite Control Panel, with the nine rotary switches, the dp/dt circuit switch, and the metal underplate for the rubbing plate. This appears to be aluminum. The rubbing plate itself can be ebony or Brazilian Rosewood (though on this machine the rubbing surface appears to have been a replacable plastic fibre of some kind. The specimen well appears to be of cast aluminum. THE THIRD PICTURE, at left, shows the nine dials of the Drown system which are based on the Sephiroth of the Tree of Life of the Western Mystery Tradition -- of significance only to to those interested in occult

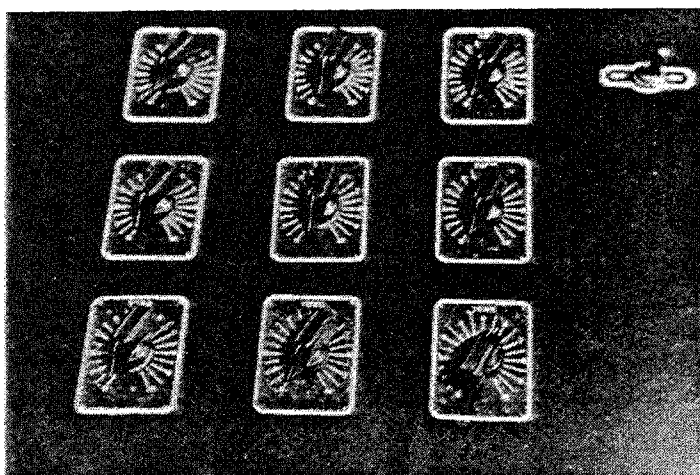

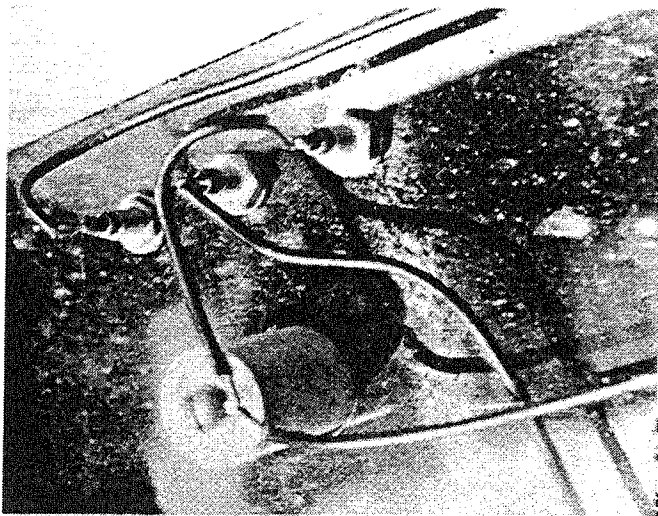

science. Though the dials are numbered from 0 to 10 (eleven positions) there are actually 12 positions or contacts on each rotary switch. The radiant energies of the 12 Constellations of the Zodiac are coming in from all directions of the Compass; so this relates the dials of the Drown instrument to those cosmic forces which hold the earth and all its inhabitants in a grip of iron.

Actual experience showed that the full-circle or 360° rotary switch, and the wire-wound potentiometer, gave the best results and finest tuning in both diagnostic and treatment work. The dials or rotary switches of the original Drown circuit had a value of 10 ohms each, from dial 1 through 9, giving a total resistance value of 90 ohms. As you can see in the picture of one rotary switch above, resistance wire was carefully looped be-

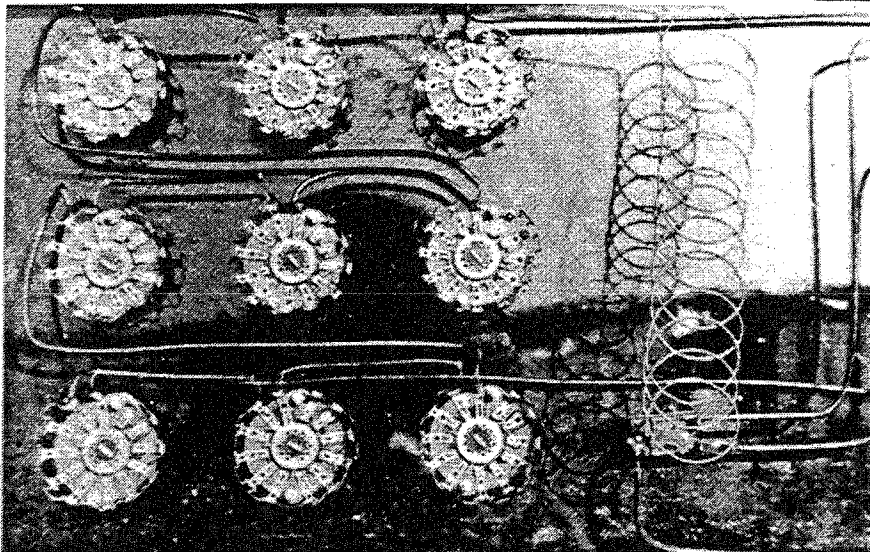
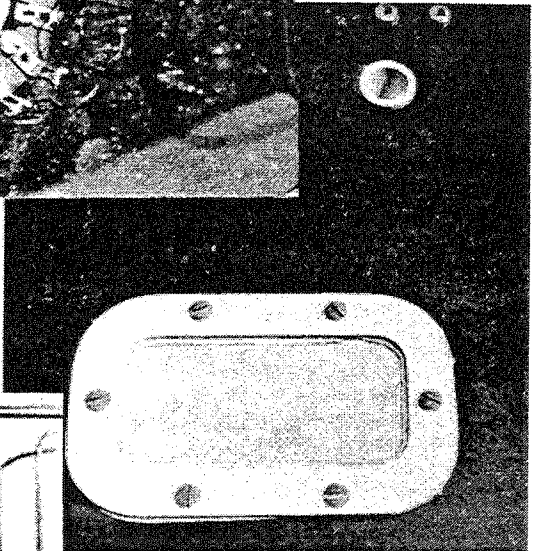
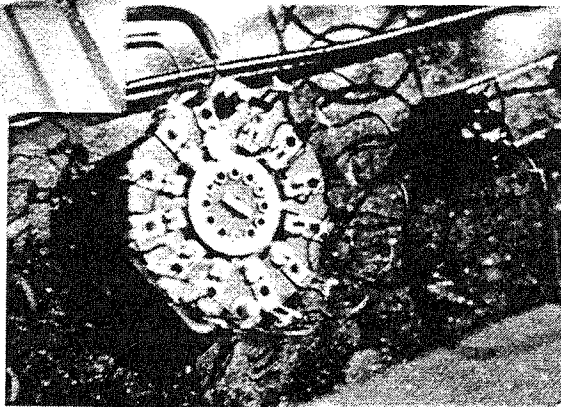

tween each contact point to give one ohm resistance between each point. More resistance in the circuit was made by the 12 loops of No. 19 bare wire you see here, with the loops soldered to each other where they overlap. But this circuit wasn't capable of the fine tuning most operators desired; so



the original Drown circuit was modified as you see in the large schematic on the preceding page, with 100 ohms total resistance in the No. 1 dial, instead of only 10. This eliminates the need for the resistance of the 12 loops of #19 bare wire in the original circuit. 10 ohms total resistance are in each of the next seven dials, and there is only one ohm total resistance in the ninth or Tuning Dial. Total resistance in the circuit is now 171 instead of 90.

Smooth-turning, wire-wound pots (variable resistors) of appropriate values can be used instead of rotary switches. These are easily available at any electronics parts store such as Radio Shack or Olson's; but it's easier and faster to set up numbers on rotary switches, and more accurate. Instead of the looped resistance wire as shown in Drown's original, carbon resistors of appropriate values can be soldered between the contact points or lugs on the rotary switches.

#### THE LIFE FORCE IS BODY-ELECTRICITY

True, there is no ordinary electricity in this circuit and none is needed; but bio-electricity or human electro-motive force is! The sceptical subject or patient can be convinced of this by the needle of the 0-500 D.C. Microampere Meter in the circuit between the Footplates and the Specimen Well.

When the subject is in circuit, with his bare feet on the Footplates and the Treatment plate on his bare belly, have him rub his hands vigorously together to generate a charge of the lowest form of electricity, static electricity -- bio-electricity in this case -- which should show as a surge of the needle all the way across the dial to 500. It wont hold though; nor is it necessary for successful operation of the equipment; for the Life Force is still there. The needle on the meter will gradually return to zero.

For more details on treatment, refer to pages 1 and 4, Part B, on the "Technic of the Homo-Vibra Ray Instrument". A separate treatment instrument can be built, using the nine dials, input for the Block Tin electrode over the patient's abdomen, and output to the German Silver Footplates and Ground.

P A T E N T   S P E C I F I C A T I O N

(British Patent Office) 515,866

Application Date: July 1, 1938                      No. 19584/38.

Complete Specification Accepted: Dec. 15, 1939

COMPLETE SPECIFICATION

Method and Means For Obtaining Photographis Images of  
Living and Other Objects

I, Ruth Drown, a citizen of the United States of America, of 4706 Oakwood Avenue, Los Angeles, California, United States of America, do hereby declare the nature of this invention and in what manner the same is to be performed, to be particularly described and ascertained in and by the following statement: --

The present invention relates to a method of and means for obtaining photographic images of parts of the human body or of other objects. One object of my invention is to enable accurate photographs of healthy and diseased parts of living bodies somewhat similar to X-ray photography to be obtained in simple and easily applied manner. Another object is to provide a compact, portable apparatus for obtaining photographic images according to the invention.

It is believed that the action obtained by my present method consists in activating the flow of electrons of the uni-directional flow of current from the battery or other equivalent source and the radiant energy of the body being examined.

In pursuance of the foregoing and according to my present invention a method of obtaining photographic images of living and other objects and more particularly human beings consists in subjecting a highly sensitized photographic plate or film to an electromotive force so as to produce a field thereon and providing means susceptible to the influence of invisible energy rays or electrons of the atoms of the object to be photographed to produce a change in voltage drop across an electrical circuit to correspondingly influence said field.

The apparatus for carrying out the invention does comprise a light-sensitive cell, a uni-directional source of current connected at the negative side of the cathode of the light-sensitive cell and at the positive side to the anode of the cell. A series of impedance rheostates connected so as to have a condenser action and connected in parallel with the cell and the source of energy,

a rectifier, and a photographing device comprising the opposed plates of a fixed condenser between which the film or plate is located, said rheostats being connected across one of the plates of the condenser and the cell plates, and the other plate of the condenser being connected to the filtered negative side of the said source.

In carrying an embodiment of my invention into practice it should be understood that the latent image is carried to the sensitized surface by means of a magnetic field having certain lines of force and the thickness or width of the field, i.e., transverse to the shortest distance between the negative and positive points, can vary from one thirty-second of an inch to an inch. This field, when applied across a sensitized surface, spreads or is trapped to the plane of such surface and by action of a suitable developer the image of the field can be printed. Consequently, if the potential of the applied force is varied by using the electronic or light ray influence of the object to be photographed to affect the photo-electric cell included in the circuit of the apparatus, the lines of force will be correspondingly varied on the plate.

In practice the subject to be photographed is placed close to the photo-electric cell and it is found that the radiant energy of the subject impinges on the cathode of the tube resulting in an increasingly higher resistance placed across the cell. Such increase will cause an exceedingly minute change of the current in the anode circuit, in turn producing a change in the voltage drop across the circuit, such voltage drop or change in potential being led through the selecting or tuning section constituted by the rheostat. That is to say a photo-electric cell is used to isolate a particular section to be photographed and in doing so it pictures changes in electro-motive force in an electrical circuit, such changes of the electro-motive force being utilised to excite the circuit producing a field across a highly sensitized emulsion surface, the resulting distortion or change of the lines of force across said surface producing an image which can be developed chemically. Suitable apparatus for achieving this result is illustrated by the appended sheets of drawings wherein: --

Fig. 1 is a diagrammatic view of a complete circuit.

Fig. 2 is a sectional side elevation view of a portable casing accommodating the cell, rheostat or tuning device, photographic plate-holder and circuit wiring.

Fig. 3 is a detail sectional plan view showing one

of the adjustable tuning devices, a number of which are suitably connected in the circuit as shown diagrammatically in Fig. 1, and assembled on a panel in the portable casing as shown in front and broken rear elevations in Figs. 4 and 5 respectively.

Referring to the drawings a source of direct or uni-directional current 1 is connected by its negative side to the cathode 2 of a photo-electric cell 3 via a filter 4 which can consist of coils of insulated wire or solenoids wound on both iron cores and air cores and in series. The source of potential may be a battery carried in the portable casing 5 so that the apparatus can be self-contained and available for use anywhere. The positive side of the source 1 is connected to the anode of the cell 3. Connected across the anode and a rectifier 7 is one, or preferably as shown, a plurality of series-coupled impedance rheostats 8 which are constructed to act as condensers, the rectifier 7 being in turn connected to the filtered negative side of the source 1 so that the rheostats are in parallel with the beforementioned circuit of the battery and cell. This rectifier may be a quartz-crystal type, a vacuum tube rectifier, a rectifier of the oxide type or a chemical rectifier. A pair of large surface area (in relation to their thickness) conducting plates 9 and 10 are located in narrowly spaced relationship, e.g., after the manner of a fixed condenser and are connected in parallel with the rectifier. This condenser device forms in effect a photographing device because between them is interposed a highly sensitized plate or film.

With the source of the potential connected as shown there will always be a difference of potential between the cathode and anode of the cell, the anode being positive to the cathode by reason of the applied direction of polarity of the source of potential.

In practice the object to be examined is placed close to the surface of the cathode so that the invisible light rays or radiations will impinge upon the cathode resulting in negative electrons being emitted from the cathode. This places a negative potential on the anode and an increased resistance is placed across the cell resulting in an exceedingly minute change of current in the anode circuit. Because of this change in current there will be a voltage drop across the circuit which is led through the selecting or tuning section constituted by the rheostats.

The changes in dielectric stress of the condenser-

like arrangement of plates 9 and 10 caused by the changes of potential applied to the plates 9 and 10, produces corresponding changes in the field which is contained in the sensitized surface of the photographic plate or film. This field is in the nature of a magnetic field with appropriate lines of force depending upon the particular setting of the tuning device constituted by the impedance rheostats 8. As the tuned in electro-motive force which produces the field is varied or regulated by the energy derived from the nervous system or organism of the living object being photographed, the field is varied accordingly.

The tuning device can comprise any suitable number of rheostats connected in series as shown in Fig. 1 to afford a wide range of adjustment. Each rheostate comprises a plurality of conductor studs 14 arranged in an arcuate path about a center conductor pivot pin 15 from which radiates a contact 16 engaging the studs singly. Each stud is lined with an insulating sleeve 17 about which is wound a wire 18 so that there is a capacity between the wire and the conductor stud 14. The windings 18 are in series for each rheostat, and the conductor pivot pin 15 of each rheostat is connected to the first winding of the next rheostat in succession as shown in Fig. 1. Such an arrangement affords a wide range of fine tuning, the impedance formed in the circuit being determined by the number of windings selected.

The rheostats can be mounted on a panel 19 fixed in the portable casing 5. A switch 20 for making and breaking the circuit of the battery can be provided on this panel, and the photo-electric cell 3 can be plugged into a socket 21 on the base of the casing between the panel 19 and a partition 22 separating a compartment 23 containing the condenser plates 9 and 10. Immediately above the space between these two plates is a narrow lid 24 adapted to light seal the compartment 23, and to be opened for insertion and removal of a mount containing the photographic plate or film.

Having now particularly described and ascertained the nature of my said invention and in what manner the same is to be performed, I declare that what I claim is:--

1. Method of obtaining photographic records of portions of human bodies or other objects consisting in forming a magnetic field across a sensitized plate or film by means of an electrical circuit and producing changes in the electro-motive force in the circuit by means of a light-sensitive cell or photo-electric cell exposed



to the influence of the radiant energy of the object to be photographed.

2. Method of obtaining photographic records of portions of human bodies and other objects consisting in creating a magnetic field by an electrical device and locating a highly sensitized photographic plate or film in the magnetic field and locating a light-sensitive cell in juxtaposition to the object to be photographed, placing a potential on the anode of the cell by means of a uni-directional source of current of the said circuit to increase the resistance of the cell and thereby produce a change in voltage drop across the circuit to the said field-producing means.

3. Apparatus for obtaining photographic records of portions of human bodies and other objects comprising means for applying a magnetic field across the sensitized surface of a photographic plate or film, a photo-electric or light sensitive cell adapted to produce changes in the electromotive force producing said field and susceptible to the influence of electrons given off by the radiant energy of the object to be examined, and tuning means connected in parallel with the cell and a source of current.

4. Apparatus for obtaining photographic records of portions of human bodies and other objects comprising a light-sensitive cell, a uni-directional source of current connected at the negative side via a filter to the cathode of the light-sensitive cell and at the positive side to the anode of the cell, a series of impedance rheostats connected in parallel with the cell and the source of current, a rectifier, and terminal members between which the film or plate is located, said rheostats being connected across one of the terminal members and the cell plate, and the other terminal member being connected to the filtered negative side of the said source.

5. Apparatus for obtaining photographic records of portions of human bodies and other objects according to claims 4 or 5, wherein the negative side of the source of current is connected to the cathode of the photo-electric or light-sensitive cell via one or more solenoids or coils of insulated wire wound on air-cores and iron cores.

6. Apparatus for obtaining photographic records of portions of human bodies and other objects according to claim 4 or 5, wherein a portable casing accommodates the electrical elements and is partitioned to screen the plate or film receiving section from the cell and the

tuning means or rheostats.

7. Apparatus for obtaining photographic records of portions of human bodies and other objects substantially as described with reference to the accompanying drawings.

Date this 1st day of 1938, RAYNER & CO.  
5, Chancery Lane, London W.C.2  
Agents for the Applicant

---

Leamington Spa: Printed for His Majesty's Stationery  
Office by the Courier Press -- 1940.

Fig. 1

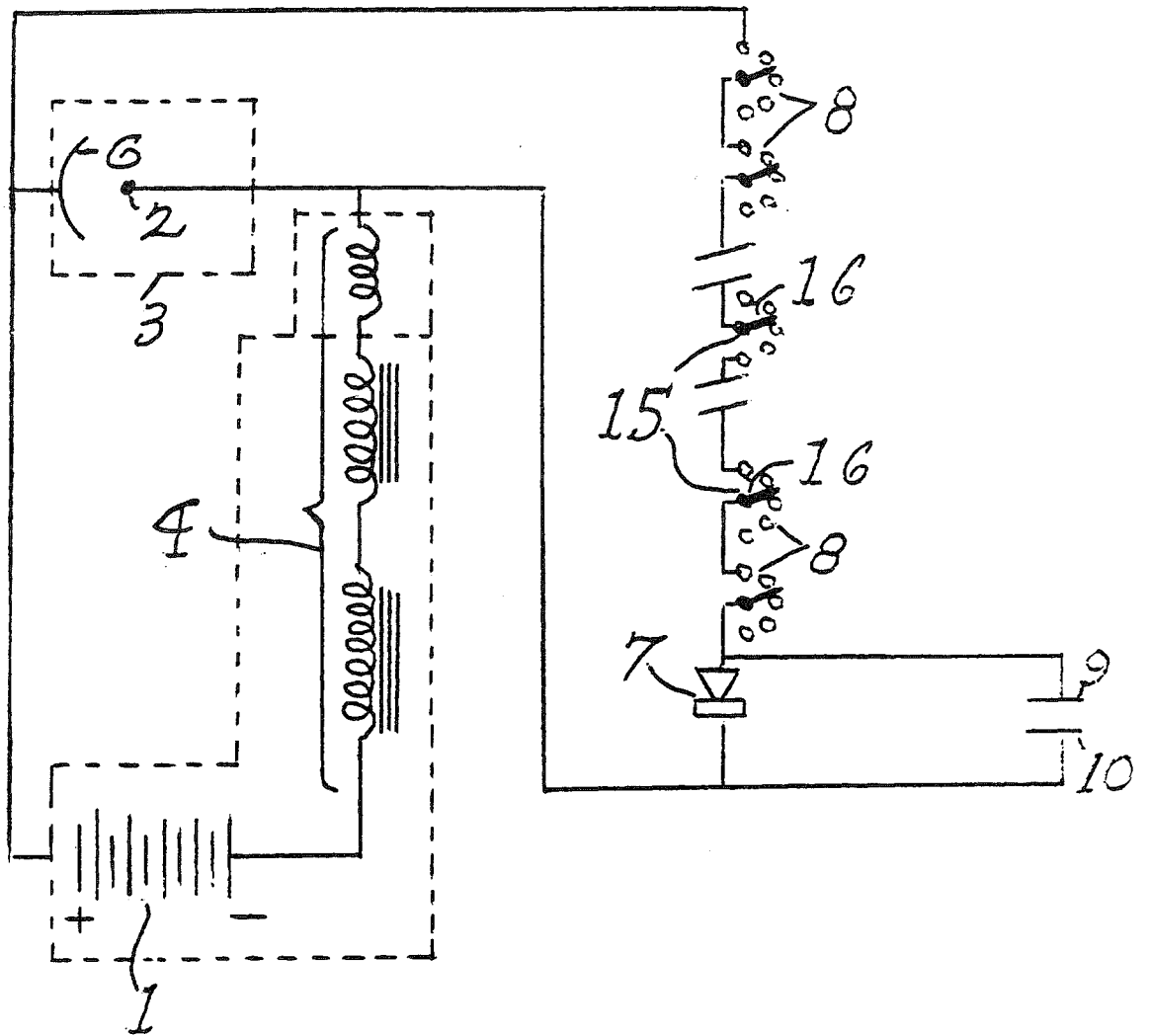

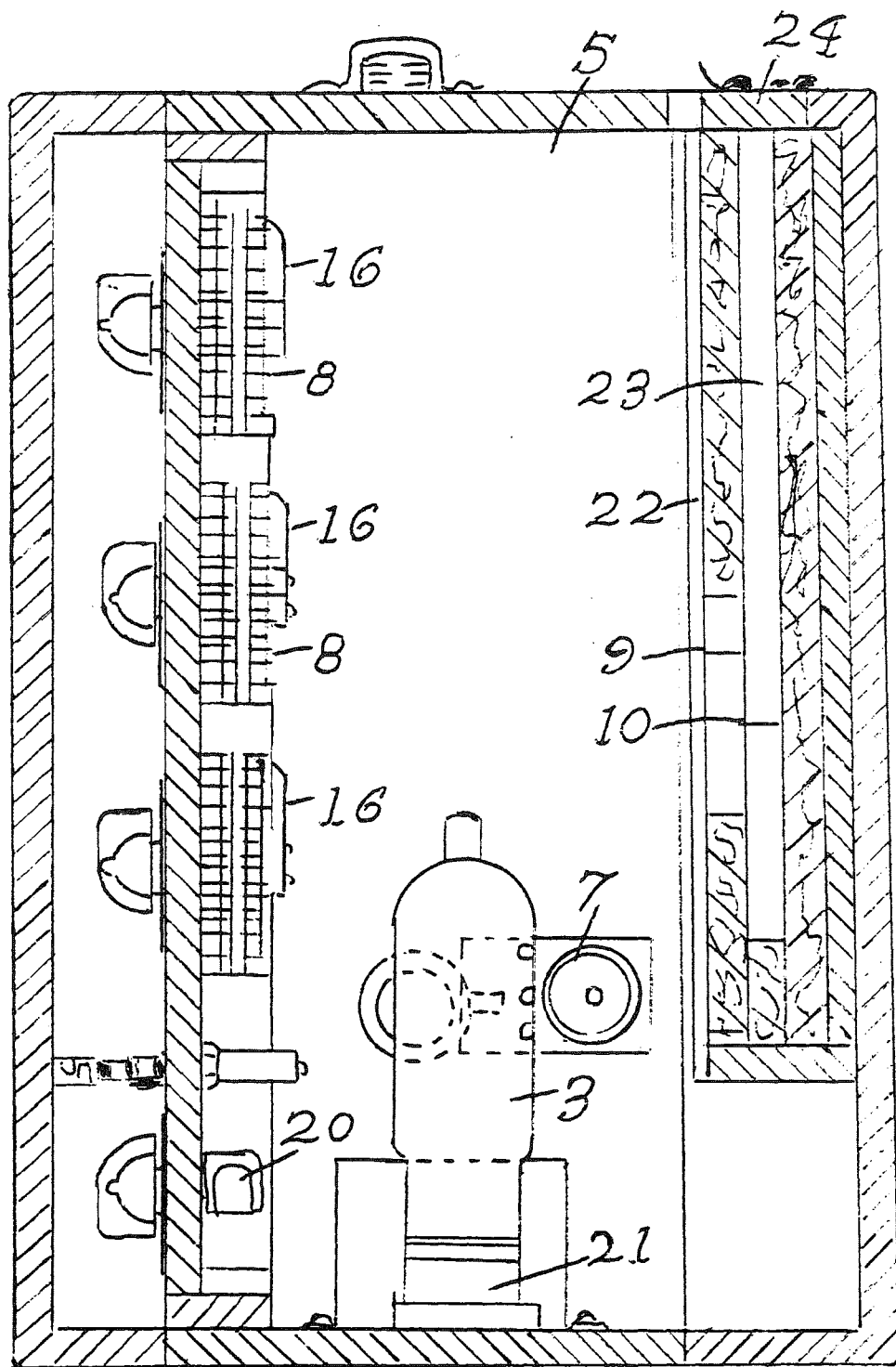

Fig. 2

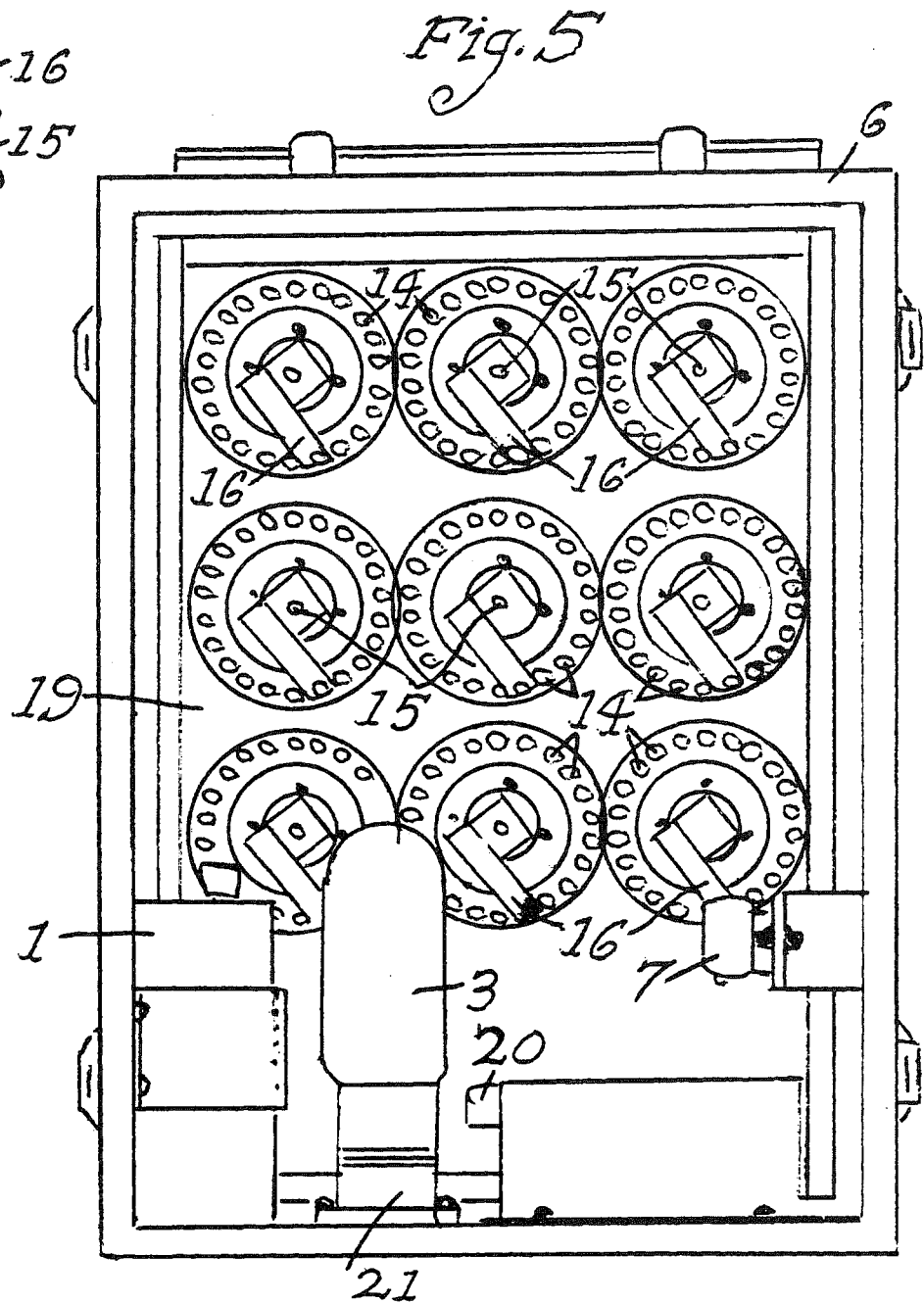
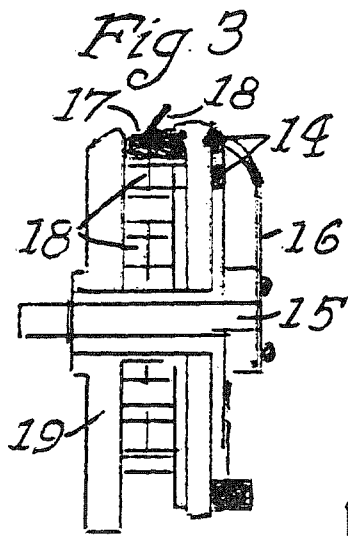
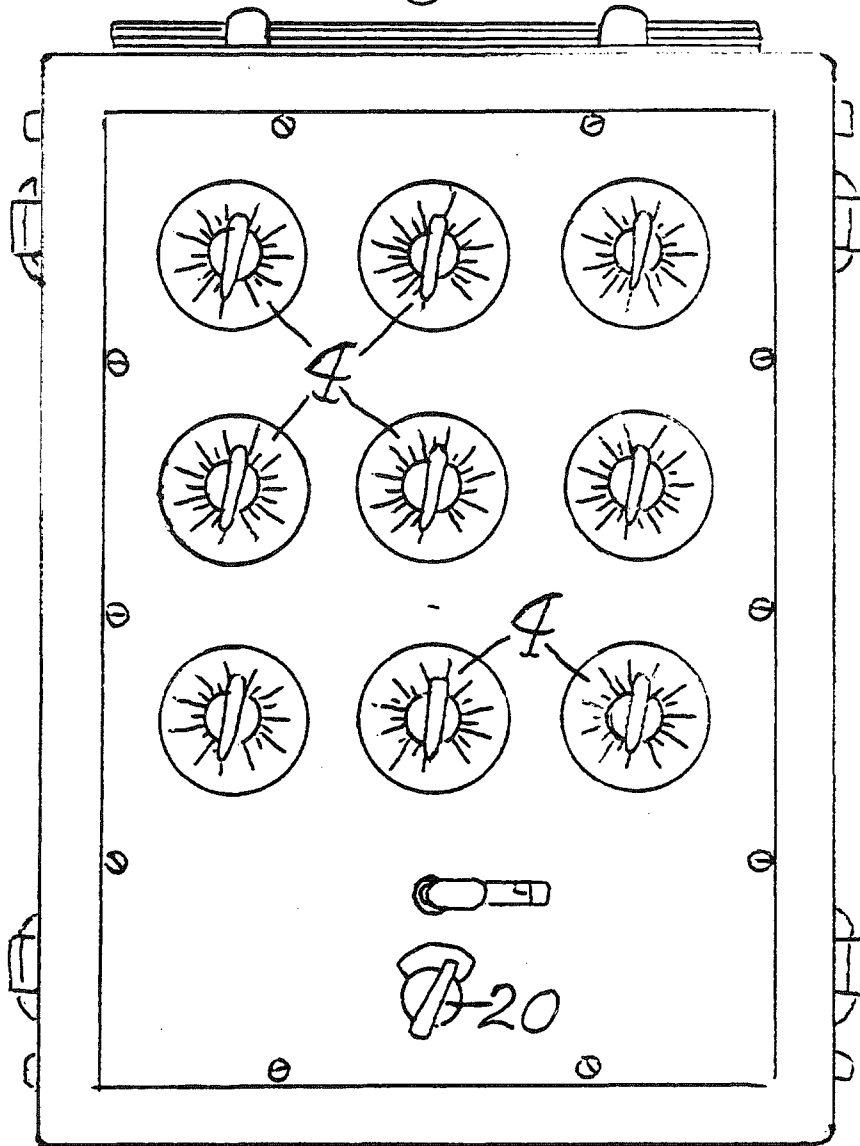

Fig. 4



## THE "VOICE-PRINT" AS SPECIMEN FOR ANALYSIS

When this gizmo is set before television, radio or telephone, the vibration of the speaker's voice passes thru the old radio speaker "microphone" and is super-imposed on the triple-distilled water in the ampule and thus becomes a living "specimen" of the person speaking which can be completely diagnosed. The ampule of water can be completely neutralized for further use on other people simply by touching it with a magnet.

The voice VR passing thru rate 2-9-6-3 on the instrument dials is fixed in the water as long as not demagnetized.

Switch speaker "mike" on for obtaining voice-specimen and reverse switch afterward to cut out mike unit and free radionic unit for diagnosis as if blood, urine, or sputum specimen, or THE patient were attached to the unit in person.

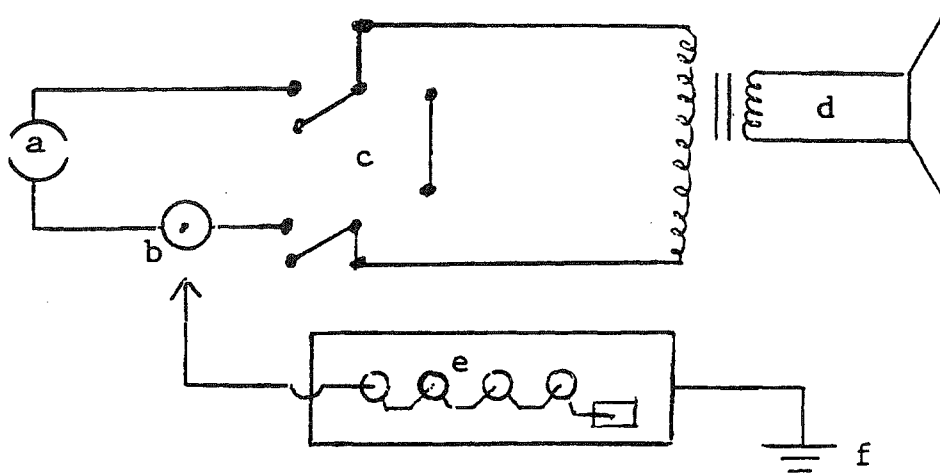

- a: Port to hold ampule of IV/IM triple distilled water
- b: Input for lead wire from Drown instrument
- c: Simple DP/DT switch (Double Pole/Double Throw)
- d: Discarded radio speaker, 4 inch, as "mike" input placed in front of TV, radio or telephone
- e: Drown 4-dial instrument set on rate 2-9-6-3
- f: Ground





8.10.88

Dear Mr Brown,

Re the Drown Atlas: The proof reading was very bad so there are lots of rates that are puzzling or misleading. I have made some corrections.

As for the plans for the photographic instrument - Dr. Drown deliberately submitted incorrect plans to the English patent office so that the instrument could not be copied and stolen which so often happens.

I have made a number of corrections - Part A - on pages 22, 23, 24, especially, a lot of first dial 0's missing. Because Dr. Drown told me that the basic atomic rate was 100-1 and that the final numbers on these rates, strangely, were the same as the element number on the Periodic Table of the elements, I was able to make corrections and find the name of the elements listed as unknown. I also had the corrected rates on the instrument checked against samples of the elements (except the unstabiles) by an expert dowser. So they are probably correct. I have underlined for your interest, the atomic numbers at the end of the element rates and also made some corrections.

Other additions or corrections are on - Part B - page 10, page 61, pages 80 through 95. Insert - p.I, p.III, p.XI, p.XII.

Unfortunately the bad proof reading has left in doubt any rates beginning with 10. Is the rate ten on the first dial or one hundred?

When rates were written by hand for use in the office they were perfectly clear. However, whoever typed the rates left a lot of puzzles. I have not been able to find anyone who could clarify the 100's and 10's.

As you probably know all conditions (diseases, etc) start with the first dials. The only part of the body on the first dial is the blood 40 9.

40	9

The blood rate put through parts of the body often will heal. The vitality rates are effective in weakened conditions: men - 40 97 12, women 40 97 11 - can be used to strengthen.

I hope you can use this information.

Sincerely,

Mary C. Cavanaugh

(NOTE: Although it was suggested here that the first dial rates be changed to 100, we have found them listed as 10 in four different sources of Drown rates. This point should be considered in your researches and both ways checked. We have not changed them, but look forward to any feedback on this matter - B.S.R.F.)

Instructions for diagnosing with Drown HVR Instrument,  
using element atom rates.

Note: The basic atomic rate is 10-1 (ten one). The last number or numbers on the rate are the same as the atomic number of the element on the periodic chart.

In checking imbalance of the element atom, we place on the instrument the rates 10-1-7-5-9-2-2-8, for SENSORY nerves, and register on the last dial the different nerves that give us a reaction.

For SYMPATHETIC nerves we place on the instrument the rates 10-1-7-3-9-2-2-8, and register on the last dial the nerves that give the reaction.

The same with the MOTOR nerves - we use rate 10-1-8-6-5-2-2-8, and register on the last dial the nerves that give the reaction.

In this way we find the cranial nerves that are out of balance; then check back on the chart. For instance, take the FIRST CRANIAL NERVE. If it registers impingement under 8-6-5-2-2-0-8, the Hydrogen and Caesium would be out of balance, their atom numbers being 10-1-0-0-0-0-0-1-1 for Hydrogen and 10-1-10-5-5 for Caesium, one being a descending branch of the nerve and the other an ascending branch.

In order to normalize the atom in the body, we would use the atomic rate of these elements and when this is held a certain length of time the unbalanced number of electrons is balanced, and the atom brought back to normal.

The same would take place in each one of the cranial nerves which would be registered on the previous check-up.

You may have many elements out of balance in the average sick patient, but holding the normal rate of vibration of the atom a certain length of time will bring it back and help to dissipate the diseased condition which in itself has caused a change of tissue structure.

You will find in the text book a complete explanation of what takes place in the body over the nervous system, and it will help you to realize that the energy which flows over the cranial nerves passes through all the chemical changes, and when no more life force can flow freely over the nerve path, the energy crystallizes and forms granulations and deposits, and the freedom of the life force through its channel will bring it back again into liquids and gases, in which state it should be in the normal healthy body.

Treat each atomic rate 10 minutes only and no more than 4 rates a day. Two weeks later treat again (10 minutes each). Do NOT treat the glands during these periods of atomic treatment.

Also further corrections: Pages 33 & 47 add the numeral 5 after the Mania rate (60495). On pages 50 & 57 the Mania rate is correct. On page 75 -Insanity - add 5 (60495). The rate 6049 is for Actinimycosis.

Treat not longer than 10 min. daily - for 1 week.  
 2-2-0-8- Grouping of Cranial Nerves.

		<u>Actual Vibratory Rate of Element Atom:</u>
<u>FIRST Cranial Nerve</u>		
Motor:	(Hydrogen descending (Caesium ascending)	10-1-0-0-0-0-1-0-1 10-1-10-5-5
Sensory:	(Palladium ascending (Rubidium descending)	10-1-1-4-6 10-1-0-1-3-7
Sympathetic:	(Tantalum ascending (Neon descending)	10-1-2-8-7-3 10-1-0-0-0-0-1-10
<u>SECOND Cranial Nerve</u>		
Motor:	(Helium descending (Sodium ascending)	10-1-0-0-0-0-2-0-2 10-1-0-0-0-0-2-1-1
Sensory:	(Copper ascending (Silver descending)	10-1-0-0-2-2-9 10-1-2-4-7
Sympathetic:	(Tungsten descending (Unknown ascending)	10-1-2-9-7-4 10-1-5-6-10-1
<u>THIRD Cranial Nerve</u>		
Motor:	(Lithium descending (Magnesium ascending)	10-1-0-0-0-0-3-0-3 10-1-0-0-0-0-3-1-2
Sensory:	(Zinc ascending (Yttrium descending)	10-1-0-0-3-3-0 10-1-0-3-3-9
Sympathetic:	(Scandium ascending (Cadmium descending)	10-1-0-0-0-3-2-1 10-1-3-4-8
<u>FOURTH Cranial Nerve</u>		
Motor:	(Beryllium descending (Zirconium ascending)	10-1-0-0-0-0-4-0-4 10-1-0-4-4-0
Sensory:	(Aluminum descending (Titanium ascending)	10-1-0-0-0-0-4-1-3 10-1-0-0-0-4-2-2
Sympathetic:	(Gallium descending (Indium ascending)	10-1-0-0-4-3-1 10-1-4-4-9
<u>FIFTH Cranial Nerve</u>		
Motor:	(Boron descending (Silicon ascending)	10-1-0-0-0-0-5-0-5 10-1-0-0-0-0-5-1-4
Sensory:	(Vanadium descending (Tin ascending)	10-1-0-0-0-5-2-3 10-1-5-5-0
Sympathetic:	(Germanium descending (Niobium ascending)	10-1-0-0-5-3-2 10-1-0-5-4-1
<u>SIXTH Cranial Nerve</u>		
Motor:	(Carbon descending (Chromium ascending)	10-1-0-0-0-0-6-0-6 10-1-0-0-0-6-2-4
Sensory:	(Arsenic ascending (Antimony descending)	10-1-0-0-6-3-3 10-1-6-5-1
Sympathetic:	(Phosphorus descending (Molybdenum ascending)	10-1-0-0-0-0-6-1-5 10-1-0-6-4-2

<u>SEVENTH</u> Cranial Nerve		
Motor:	(Nitrogen descending	10-1-0-0-0-0-0-7-7
	(Massium ascending	10-1-0-7-4-3
Sensory:	(Manganese descending	10-1-0-0-0-7-2-5
	(Selenium ascending	10-1-0-0-7-3-4
Sympathetic:	(Sulphur descending	10-1-0-0-0-0-7-1-6
	(Tellurium ascending	10-1-7-5-2
<u>EIGHTH</u> Cranial Nerve		
Motor:	(Oxygen descending	10-1-0-0-0-0-8-0-8
	(Chlorine ascending	10-1-0-0-0-0-8-1-7
Sensory:	(Bromine descending	10-1-0-0-8-3-5
	(Ruthenium ascending	10-1-0-8-4-4
Sympathetic:	(Iron descending	10-1-0-0-0-8-2-6
	(Iodine ascending	10-1-8-5-3
<u>NINTH</u> Cranial Nerve		
Motor:	(Fluorine descending	10-1-0-0-0-0-9-0-9
	(Cobalt ascending	10-1-0-0-0-9-2-7
Sensory:	(Krypton descending	10-10-0-9-3-6
	(Rhodium ascending	10-10-9-4-5
Sympathetic:	(Argon descending	10-1-0-0-0-0-9-1-8
	(Xenon ascending	10-1-9-5-4
<u>TENTH</u> Cranial Nerve		
Motor:	(Potassium ascending	10-1-0-0-0-1-1-9
	(Gadolinium descending	10-1-1-9-6-4
Sensory:	(Lead ascending	10-1-3-7-8-2
	(Nickel descending	10-1-0-0-1-2-8
Sympathetic:	(Protoactinium descending	10-1-4-6-9-1
	(Fermium ascending	10-1-5-5-1-0-0
<u>ELEVENTH</u> Cranial Nerve		
Motor:	(Calcium descending	10-1-0-0-0-2-2-0
	(Strontium ascending	10-1-0-2-3-8
Sensory:	(Barium descending	10-1-1-1-5-6
	(Bismuth ascending	10-1-3-8-8-3
Sympathetic:	(Torbium descending	10-1-2-0-6-5
	(Uranium ascending	10-1-4-7-9-2
<u>TWELFTH</u> Cranial Nerve		
Motor:	(Lanthanum descending	10-1-1-2-5-7
	(Rhenium ascending	10-1-3-0-7-5
Sensory:	(Dysprosium descending	10-1-2-1-6-6
	(Polonium ascending	10-1-3-9-8-4
Sympathetic:	(Neptunium ascending	10-1-4-8-9-3
<u>THIRTEENTH</u> Cranial Nerve (Upper octave of 4th)		
Motor:	(Cerium descending	10-1-1-3-5-8
	(Holmium ascending	10-1-2-2-6-7
Sensory:	(Astaltine ascending	10-1-4-0-8-5
	(	
Sympathetic:	(Osmium descending	10-1-3-1-7-6
	(Plutonium ascending	10-1-4-9-9-4

FOURTEENTH Cranial Nerve (Upper octave of 5th)

Motor:	(Praseodinium ascending	10-1-1-4-5-9
	(Erbium descending	10-1-2-3-6-8
Sensory:	(Iridium descending	10-1-3-2-7-7
	(	
Sympathetic:	(Radon descending	10-1-4-1-8-6
	(Americum ascending	10-1-5-0-9-5

FIFTEENTH Cranial Nerve (Upper octave of 6th)

Motor:	(Thulium descending	10-1-2-4-6-9
	(Francium ascending	10-1-4-2-8-7
Sensory:	(Neodmium descending	10-1-5-6-0
	(Platinum ascending	10-1-3-3-7-8
Sympathetic:	(Curium ascending	10-1-5-1-9-6

SIXTEENTH Cranial Nerve (Upper octave of 7th)

Motor:	(Radium descending	10-1-4-3-8-8
	(Gold ascending	10-1-3-4-7-9
Sensory:	(Promethium descending	10-1-1-6-6-1
	(Ytterbium ascending	10-1-2-5-7-0
Sympathetic:	(Berkelium ascending	10-1-5-2-9-7

SEVENTEENTH Cranial Nerve (Upper octave of 8th)

Motor:	(Samarium descending	10-1-1-7-6-2
	(Mercury ascending	10-1-3-5-8-0
Sensory:	(Lutetium descending	10-1-2-6-7-1
	(	
Sympathetic:	(Actinium descending	10-1-4-4-8-9
	(Californium ascending	10-1-5-3-9-8

EIGHTEENTH Cranial Nerve (Upper octave of 9th)

Motor:	(Europium descending	10-1-1-8-6-3
	(Thallium ascending	10-1-3-6-8-1
Sensory:	(Hafnium ascending	10-1-2-7-7-2
	(Thorium descending	10-1-4-5-9-0
Sympathetic:	(Einsteinium ascending	10-1-5-4-9-9

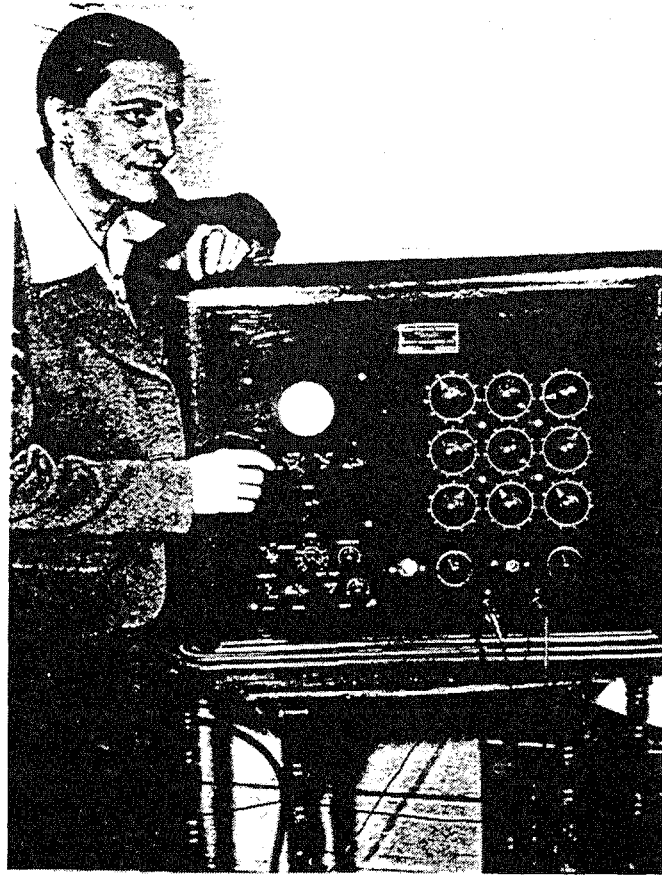

NOTE: These rates are not part of the Drown system but have been used in conjunction with them by some radionic researchers such as Peter Lindemann. We are including them for those who wish to use them in their research.

### ACTIVITY CTRS.

The following Ctrs. are all located in the Base of the Brain, except the Mucosal Activity Ctrs., which are located in the supraorbital region. These Ctrs. seem to be diseased before the organ or system is affected, and are generally in a worse condition, than the work of the organ or system would indicate. For a cure these Activity Ctrs. must be brought back to normal. The rate for the Activity Ctr., that is to be tested, is put up on the first reflexophone. The S. V. area is to the left of the umbilicus, and the percentage is measured on the tenths and hundredths.

Bone Activity Ctrs., Rt. 134; Lft. 144.	
Joint Activity Ctr., 633, Rt. and Lft. side.	
Muscle Tendon Activity Ctr., 367.	
Integument Activity Ctr., 646, Rt. and Lft. side.	
External Mucosal Ctrs., 646. Rt. 355, Lft. 345, using 729.	
Internal Mucosal Ctrs., 646. Rt. 355, Lft. 345, using 711.	
Paresis Activity Ctr., 746, in health 0.	
Arterial System Activity Ctr., 392, Rt. and Lft. side.	
Paresis Activity Ctr.....	764
Integument Activity Ctr.....	646
Joint Activity Ctr.....	633
Sexual System Activity Ctr.....	523
Gall Bladder Activity Ctr.....	513
Sympathetic Nervous System Ctr.....	503
Spinal Cord Activity Ctr.....	493
Cerebellar Activity Ctr.....	483
Cerebral Activity Ctr.....	473
Activity Ctr. for Balancing Ctr.....	463
Thoracic Duct Activity Ctr.....	453
Bladder, Urethral Activity Ctr.....	443
Colon Activity Ctr.....	433
Ears Activity Ctr.....	423
Teeth, Gums Activity Ctr.....	413
Eyes Activity Ctr.....	403
Ileum Activity Ctr.....	393
Tongue Activity Ctr.....	383
Pleural Activity Ctr.....	373
Sinuses Activity Ctr.....	363
Trachea, Bronchi Activity Ctr.....	353
Spleen Activity Ctr.....	343
Tonsils, Salivary Gls., Activity Ctr.....	333
Heart Activity Ctr.....	323
Liver Activity Ctr.....	313
Lung Activity Ctr.....	303
Pancreatic Activity Ctr.....	293
Lymphatic System Activity Ctr.....	283
Venous System Activity Ctr.....	273
Stomach Activity Ctr.....	263
Pineal Body Activity Ctr.....	253
Kidneys Activity Ctr.....	243
Lft. Aortic Ganglion Activity Ctr.....	233
Rt. Aortic Ganglion Activity Ctr.....	223
Lft. Carotid Body Activity Ctr.....	213
Rt. Carotid Body Activity Ctr.....	203
Aortic Bodies Lft. Side Activity Ctr.....	193
Aortic Bodies Rt. Side Activity Ctr.....	183
Lft. Adrenal Activity Ctr.....	173
Rt. Adrenal Activity Ctr.....	163
Lft. Parathyroid Activity Ctr.....	153
Rt. Parathyroid Activity Ctr.....	143

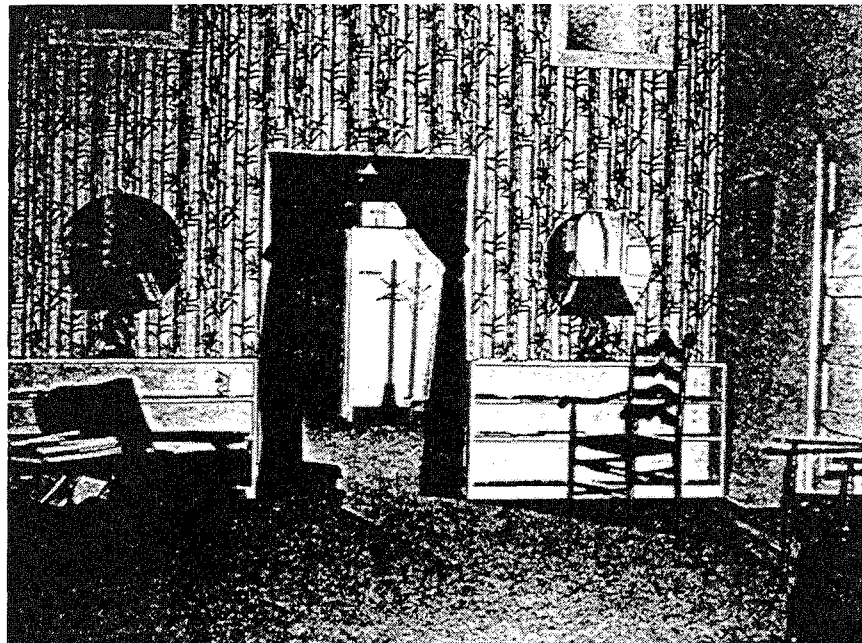



blank

PART B  
TECHNIC OF THE HOMO-VIBRA RAY  
INSTRUMENT

The Homo-Vibra Ray is set up by placing the ground wire in position and fastening it preferably to a water pipe or a gas pipe making direct contact with the ground, or by attaching it to a metal rod running into the ground. The foot-plates are placed in the two openings marked "F" and the treatment cord placed in the opening marked "P".

When diagnosing, the foot-plates only are used, unless the operator wishes to localize over the patient's body. The foot-plates should be cleaned thoroughly with alcohol between patients.

Each patient must have his own electrode for treatment. If one patient's electrode is used on another patient, pain will be created in the second patient. The electrodes may cover all areas where the diagnosis has shown treatment is needed, or may be placed on one area and the other areas localized in the instrument.

Never attempt to treat a patient without first attaching the instrument to the ground. If the instrument is not grounded, the patient will not lose his pain and will be very much depleted.

(Let us say here for the benefit of those who do not know, that any patient who is weak and depleted should never take shower baths and stand in water over the drain, because the patient's magnetism is washed down with the water through the drain, leaving him depleted. Also, a weak patient, after having had a tub bath, should leave the tub and have someone else drain the water and clean the tub. If it is necessary to do this himself, he should leave the tub and put on a robe before starting to drain the tub. Too many people sit in the tub and drain the water while finishing the bath, and their own magnetism is drained through the drain pipes to the ground, leaving the patient with that much less reserve.)

In diagnosing with this instrument, the operator must first become thoroughly familiar with the disease detector, by passing the hand from the right side to the left in the vicinity of the center, horizontally across the detector with the proper speed of arm movement and with definite pressure from the

fingers upon the surface of the detector. After repeated attempts the operator will finally be able to distinguish the disease, or so-called "stick" on the detector from that of the ordinary rubber stick.

There is no electricity used in the instrument, but the patient should never make contact with electricity while on the instrument, for he is grounded to the earth and becomes part of the circuit. To do so could be very dangerous.

The grouping of the rates of vibration has been brought about with two definite principles in mind. The disease rates (which does not mean disease necessarily as the average layman knows it, but anything abnormal to the tissue) are registered on the master dial at the beginning, and the organ, gland and body tissue rates follow on the other dials. Thus, if cancer is registered, we would localize it through the different organs and tissues in this manner: Fifty, which is our rate for cancer, would be placed on the master dial and we would then proceed to look through the different body rates for localization. If registered in the right kidney, our rate would be 5037 (37 being our rate for the right kidney). While localizing disease in other organs, we would take off the rate for the right kidney. If it should register in another organ also, it would be possible to treat the two areas at one time if there are enough dials on the instrument to cover the rates.

In diagnosing, begin with the chart (Part A, Page 19) given to each doctor with his instrument. The master dial is turned to 0, and all glands and organs are located on the following dials, beginning with the second dial, and the function is measured on the ninth or 1/10 measuring dial. Commence with the suprarenal glands shown first on the chart, and follow in order. When turning from the right suprarenal (31072) to the left suprarenal (31078) it is necessary to turn only the fifth dial, changing the 2 to 8, which gives us the suprarenal gland. In checking the parathyroids, the second dial is the dial which is turned and the third dial is left on rate 9; as for the upper right parathyroid, the second dial is set at 5 and the third dial at 9; the lower right, the rate is 69; the upper left, the rate is 79; the lower left, the rate is 89.

Disease, inflammation, etc., are all localized through the instrument in any tissue or part of the body for which a rate is given. There will be new

rates and new discoveries from time to time. Each doctor possessing one of these instruments will be sent supplements to this article accordingly.

The principle of the Homo-Vibra Ray instrument is based on the theory that there are strata of different rates of vibration in the air circling the earth, as well as strata of different rates of vibration of rock, etc., through the earth, one being the solidification of the other. Therefore, our group of dials represents a group of strata of rates of vibration the same as the octaves on a piano. If we were to place our dials, theoretically speaking, one on top of the other, we would find that any number, for instance 10 on the master dial or 10 on the other dials, is in perfect harmony with the 1/10 on the measuring dial, and so on through the group of dials, only each dial would represent a different rate of vibration on the scale of music, we find the notes A or E or any note chosen, to be in perfect harmony with the same note on each octave, but with a different rate of vibration.

#### ENERGY FLOW, POSITIVE TO NEGATIVE

The principle of diagnosing with the Homo-Vibra Ray is that all positive energies flow toward the negative energies. Thus the positive force in the human body flows toward the ground, as our instrument is grounded. In using the human energy as the force that carries the radio-active ethers from the body to the ground, we are not able to pick it up at the present time by any other than that which is equal in every way to the human energy -- hence the reason for passing the hand over the detector to pick up the disease rate of vibration as it passes toward the ground. We find that the disease energy is positive to the ground energy, but it is negative to the total body energy, being but a small part thereof. Therefore it is that positive energy of the operator emanating from the tips of the fingers, coming in contact with the detector which causes a definite short in the passage of the disease energy or vibration from any localized tissue, organ or gland of the body. Any one of these, being but a part of the great whole, naturally is negative to the total. Any other energy would be a different rate of vibration and would take us out of the law that "like attracts like".

It has been difficult for the average physician to recognize the great vital life force which flows through everything in the universe, giving it its own

rate of vibration. When that rate of vibration changes, the substance recognized as a definite thing ceases to be that thing and becomes something else without ceasing to be a substance. Were commercial electricity used with this instrument, we would defeat our own purpose to the degree that we would waste the electric energy, for it would not find its own rate of vibration in the human body, and we would also obscure the flow of human energy to such a degree that the patient would receive only a portion of the treatment that he otherwise would receive were he to treat with his own energy unobscured.

Therefore, treatment with the Homo-Vibra Ray is a reversal of the polarity of the patient by sending the energy out through the electrode (contrary to the previous idea that the energy passed in through the electrode) back through the instrument through the definite rates discovered in our diagnosis and back to the body by way of the feet. When diagnosing, the energy leaves the body, passing toward the ground from the feet through the foot-plates. However, it is possible to diagnose with the patient hooked-up for treatment.

#### METHOD OF RUNNING A BLOOD COUNT

The master dial, instead of being used as a disease dial, is combined with the second dial for the blood rate (409). On the third dial the rate 1 is used, which gives 40 on the master dial, 9 on the second dial and 1 on the third dial, or 4091, our rate for haemoglobin. Then on the ninth dial (this being the 1/10 or measuring dial when used for measuring, but which may be used for definite treatment), turn to 10 and keep turning towards 0, passing the hand over the detector at least three times to each number before moving to the next. When a "stick" is received on the detector, we know that our rate registers at that number, and then we look at the chart in our Atlas and translate it, such as: 3/10 equals 103.0 haemoglobin on the chart. This chart seems to be high according to some authorities, but do not confuse haemoglobin with the color index, for it is very convenient to be able to designate the amount of haemoglobin and red corpuscles when dealing with a case of pernicious anaemia and differentiate it from secondary anaemia. In such cases it is almost invariably the rule that the haemoglobin content will be high and the color index low. The scale does

not matter, so long as the results can be read and interpreted.

The color index is found by multiplying the number of Erythrocytes by two and dividing the haemoglobin by the first two figures of this product and subtracting the result from 100.

#### METHOD OF MEASURING TEMPERATURE (Broadcast or Direct)

The master dial is placed on 40, the second dial on 5, the third, fourth, fifth and sixth dials on 0, the seventh dial on 9, the eighth dial on 8, the ninth or 1/10 measuring dial on 10. Then start passing the hand over the detector and moving the measuring dial down until the rate is found on which it shorts, or a "stick" is received, and if that rate happens to be 6/10, the other two dials being on 9 and 8, the rate will be 98.6 which is normal. However, if the dial gives a reaction when placed on 10, the operator would immediately know that the temperature was higher than 98.0. Then the ninth dial should be turned off and the eighth dial turned up to 10, which would read 90 and 10, or 100. If the reaction still registers, turn the seventh dial to 10, which would give the equivalent of 100 and the eighth dial would then read the addition, such as 10 and 8, 10 and 6, 10 and 2, whatever the number might be, and the tenths would be registered on the ninth dial, such as 102.4.

#### TECHNIC OF RUNNING THE URINE ANALYSIS

A very good idea of the kidney condition is obtained after making a complete test, so it is suggested that this be held as the last test in the diagnosis, and that it be checked with wisdom and understanding of the case, because it is found in dealing with the excretion of the urine, that the clinical test made in our laboratory is made with the urine after it has passed from the body and the test made of the urine in the body of the patient before being passed, gives a closer check-up of the condition. The results may be slightly different by the time the urine has passed from the body, such as the amount of specific gravity, crystals, etc. This depends on how many solids are retained in the body and the amount of water the patient has taken previous to micturition.

However, the technic is the same as in other tests; 609 is the urine rate in the body, 60 being

placed on the master dial and 9 on the second dial with the different rates on the following dials. In running the specific gravity, place 60 on the first dial, 9 on the second dial, 8 on the third dial, 7 on the fourth dial, 1 on the fifth dial, 0 on the sixth dial. To measure from 30 down (nothing above 30), place the last three dials on 10. Begin moving the ninth dial down until a reaction is registered. If 9 registers on the ninth dial, 10 and 10 on the seventh and eighth dials (10 and 10 equaling 20), the registration would read 1.020 and 9, or 1.029 specific gravity. If the specific gravity is not that high, the ninth dial may be entirely eliminated. If a "stick" is registered with the seventh dial on 10 and the eighth dial on 7, the specific gravity would be read 1.010 and 7, or 1.017.

The main part of our diagnosis is done by following the chart given with this instrument for the doctor's own use. (The doctor may give us the order for this printing, or he may give his own printer the work to do.) On this chart is given the function of all glands and organs of the body needed to designate a diagnosis. Diseases not shown on the chart are listed in the Atlas.

#### METHOD OF DETERMINING IMPINGED NERVES

(Our rate for impinged nerves is also called blocked nerves.) When there is an impingement, there will be a reaction on the detector. Cranial nerves are designated by the rate 2208, and the dial board will read 90632208, with the last two dials registering the number of the nerve impinged, e.g., 1 on the eighth dial, 2 on the ninth dial is the twelfth cranial nerve. The eleventh cranial nerve is found in the same way, 1 on the eighth dial and 1 on the ninth. Now turn the eighth dial to 0 and register on the ninth dial the tenth to the first cranial nerves. The cervical nerves are designated by 906344, with 0 on the sixth, seventh and eighth dials, measuring on the ninth dial, beginning with 8, the eighth cervical nerve, registering down to the first cervical nerve. The dorsal region is designated by rate 2 -- thus the dial board will read 90632, with 0 on the fifth, sixth and seventh dials, leaving the eighth and ninth dials to designate the number of the nerve impinged, e.g., 1 on the eighth dial and 2 on the ninth dial, designates the twelfth dorsal, and 1 on the eighth dial and 1 on the ninth, designates the eleventh dorsal. Then turn the eighth dial to 0, and register on the ninth dial from the tenth dorsal to the first dorsal.

The rate 21 is given to the entire lumbo-sacral-coccygeal area, because of the fact that the spinal cord ceases to grow much past the second lumbar. Thus, for the first coccyx, or ano-coccygeal nerve, the dial board will read 90632100 with 1 on the eighth dial and 1 on the ninth dial. Then turn the eighth dial off and the ninth dial to 10, and this is read as the fifth sacral. 9 as the fourth sacral, 8 as the third sacral, 7 as the second sacral, 6 as the first sacral. This brings 5 into its normal position as the fifth lumbar, and 4, 3, 2 and 1 as corresponding lumbar.

The function of any part of the body not otherwise designated on our chart is regarded as registering 10/10 normal function. For instance, take the right coronary artery of the heart -- while the heart muscle itself is designated as 4/10 normal function, the arteries (also the veins) throughout the body have a function of 10/10. If the right or left coronary artery registers low in function, the patient's condition is apparent. This is true of any part of the body.

Where there is a right and left organ and but one rate is given in the Atlas it is considered as the rate for the right organ, and the addition of 1 will give the rate for the left organ. Where there are exceptions to this rule, the rates for both the right and left organs are given in the Atlas.

#### FOR LOCALIZATION OR MEANS OF A CHECK-UP

To confirm the findings on the patient: place the disease rate on the instrument and pass the metal part of the treatment cord over the area of the patient's body where the disease has been localized through the instrument. When that particular area is touched, a reaction will be received on the detector. The metal part of the cord may be placed directly on the skin, but the energy will pass through the clothes as easily and efficiently.

#### METHOD OF PREPARING SPECIFIC REMEDIES USING SUGAR MILK PELLETS

It is suggested that the operator get any potency desired from the Homeopathic pharmacy, free from alcohol if possible, and also procure some sugar milk pellets, dry. In the specimen container of the instrument place a vial of the remedy to be used for poten-



tizing the plain sugar milk pellets. Turn all the dials to 0. Begin with 0 on the master dial, going upward until a reaction is obtained on the detector. Proceed with the second dial likewise; then the third and so on until all the dials on the instrument have been used in the same way. Write this rate in a book opposite the name of the remedy and keep for future use. Now, place on the foot plates a small piece of block tin of the type used for treatment electrodes, bent in the shape of a container. In this container place the sugar of milk pellets and fasten it to the foot-plates with the treatment cord. Leave the instrument set at the rate of the remedy and potentize until the sugar milk pellets register a "stick" when the remedy is removed from the specimen container.

Give the radio-potentized pellets to the patient, six of the small pellets, or three of the larger size every two hours the first day; every four hours the second day, and so on until there is an interval of twelve hours between doses. Then change the potency of the pellets to the next higher degree, and so on until the condition is eliminated. We find that many individuals lack certain cell salt vibrations which can be supplied in this way, thus hastening the healing.

This instrument is also used for broadcasting, but since we do not use this as regular treatment, we give it only as a method still in its infancy, although many vital cases have been healed through this medium. To broadcast, place the blood sample in an envelope and connect it by the treatment cord to the foot-plates. The blood is always in tune with the patient as it is the only thing which maintains the same vibration throughout life.

#### METHOD OF DETERMINING BLOOD PRESSURE

Place the blood pressure rate on the instrument (40 on the master dial, 9 on the second dial, and 0 on the third dial), and determine whether the pressure is hyper (49096), hypo (490768) or normal (490374). The use of the computing system of adding 100 to the age of the patient and subtracting 10 will give the approximate normal blood pressure. To obtain the systolic pressure, add the systolic rate (142) to the blood pressure rate. Use the last three dials for measurement, the seventh and eighth dials signifying 100's and 10's respectively. The

diastolic pressure is obtained by adding the diastolic rate (149) to the blood pressure rate, and using the eighth and ninth dials, considering the points on the eighth dial as 10's.

BLOOD PRESSURE. . . . .	490
Hyper (over). . . . .	49046
Hypo (under). . . . .	490768
Normal. . . . .	490374
Diastolic . . . . .	490149
Systolic. . . . .	490142
Tension . . . . .	4904947

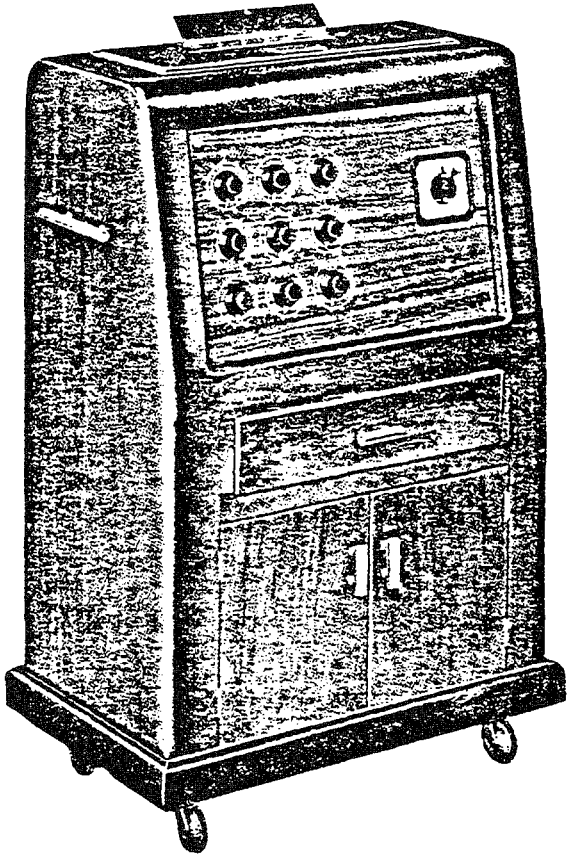

The Drown Radio-Vision Instrument

## THE ENDOCRINE GLANDS

**SUPRARENALS** Secrete adrenalin, which controls in a  
**R-31072** measure the function of the blood  
**L-31078** vessels, especially through the sym-  
pathetic nerves. There is a very direct  
connection between the function of the suprarenals and  
the thyroid, the intestinal secretions, kidneys, lungs and  
heart.

**PINEAL** Secretions control brain growth in the young,  
**98** and continue to control cell growth of brain  
and nerve tissue in the adult.

**PITUITARY,** Secretes a hormone controlling the growth  
**ANTERIOR** of the long bones, which are blood-form-  
**694** ing, and also of the blood-forming bone-  
marrow. It is very directly connected  
with the sex function in the adult, and its lack of func-  
tion promotes lack of vitality and weakness when in con-  
junction with devitalized sex organs.

**PITUITARY,** Secretes pituitin, which in turn flows  
**POSTERIOR** through the fluid in the spinal cord and  
**698** feeds the nerves as they pass through the  
meningeal tissue. It also controls the  
cell growth of the skin, which is formed by the same germ  
layer in the embryo as the nerve and brain. Its lack  
of function is usually found where the skin suppurates  
and fails to heal, such as in lympho-sarcoma.

**PANCREAS** THE HEAD puts forth an internal  
**9972-HEAD** secretion (although this is not gen-  
**997-TAIL** erally accepted) which assists the di-  
**99719-ISLANDS** gestion of fats and carbohydrates.  
**OF LANGERHANS** Disease of this part causes the symp-  
toms of ulcerated stomach and gas-  
tritis.

THE TAIL secretes pancreatin, which empties through  
the duct of Wirsung into the duodenum and assists in  
digestion of fats, etc.

THE ISLANDS OF LANGERHANS secrete insulin. Their  
lack of function usually comes after a prolonged over-  
function, which has digested so much of the carbohy-  
drates from the liver that the system is unable to handle  
the sugar and it is passed out through the kidney.

**UTERUS** It is not definitely known that the uterus  
**954** has an internal function. However, as an  
organ of elimination in the female its lack  
of proper function often produce tumors.

**OVARIES** The internal secretions of these glands act  
**R-338 Int.** to keep in circulation the minerals of the  
**R-336 Ext.** body, such as phosphorus, sodium chloride,  
**L-334 Int.** calcium and iron. This function seems to  
**L-332 Ext.** be almost directly under the control of the  
corpus luteum. The external function, while  
assisting in the formation of human bodies, produces a  
secretion which also definitely controls the growth cells  
in the parent body.

**PROSTATE** Lack of prostatic function in the male often  
**999** produces weakness of the legs and flabbiness  
of the skin, and occasionally a disconnection  
between brain and limbs through the motor nerves.

**TESTICLES** The internal function of the testicle acts to  
**R-788 Int.** keep in circulation the minerals of the body,  
**R-786 Ext.** while the external function is used for gen-  
**L-781 Int.** erative purposes and secretes a substance  
**L-782 Ext.** which controls the growth cells in the parent  
body.

**THYROID** While the thyroid gland secretes thyroïdin,  
**R-687** it also has a definite action upon the brain  
**L-6871** cells and the sympathetic nervous system.  
This in turn controls the circulation and  
reacts upon the generative organs. It definitely governs  
the formation of toxins, and reacts on the small intestine,  
kidneys, suprarenals and lungs.

**PARATHYROIDS** **THE UPPER RIGHT** controls the tox-  
**UPPER R-59** ins, calciums, and the function of the  
**LOWER R-69** nerves of the head and neck.  
**UPPER L-79** **THE LOWER RIGHT** controls the tox-  
**LOWER L-89** ins, calciums, and the function of the  
nerves of the body and limbs.

**THE UPPER LEFT** controls the toxins, calciums, and the  
blood vessels of the head and neck.

**THE LOWER LEFT** controls the toxins, calciums, and the  
blood vessels of the body and limbs through the sympa-  
thetic nervous system.

**SPLEEN** Acts to filter the blood, segregating the  
**465** worn-out red cells, and starting the forma-  
tion of bile. It also filters the worn-out  
white cells and starts the formation of lymph. In addi-  
tion, it controls the formation of red and white cells in  
the bone-marrow.

**LYMPH** Act as scavengers of the toxic poisons of the  
**GLANDS** body, controlling their elimination through  
**327** the circulatory system.

## GENERAL DISEASES

### Diseases

Abdominal Hemorrhage .....	7049
Abdominal Hernia .....	104859
Aberration, functional .....	5033
Abscess, Cerebral .....	30244
Abscess, Gastric .....	302321
Acetonemia (Diabetes Mellitus) .....	5094
Acetonuria .....	609969
Acidity .....	407
Acidity, sub (stomach) .....	551
Acid Diarrhoea .....	7064
Acidosis .....	5
Acoustic Atrophy .....	906228
Adenitis .....	90126
Adhesions .....	5011
African Sleeping Sickness .....	90898
Albuminuria .....	609779
*Amentia .....	80924
Amnesia .....	80624
<u>Amoeba</u> .....	<u>6073</u>
Amyloid Disease .....	50199
Amyloid, Tissue Infiltration .....	7095
Anaemia, Arterial .....	40972
Aneurysm, Aortic .....	4052
Aneurysm, Carotid .....	40894
Ankylosis .....	1073
Anthrax .....	4019
Aneuria .....	609711
Anxiety States .....	90769
Aorta Stenosis (Obstruction) .....	10911
Aphasia .....	1026
Aphasia (Hysterical) .....	10763
Arrhythmias (Cardiac) .....	906322810
Arterial Contusion .....	409735
Articular Fever .....	90279
Atrophic Emphysema .....	10277
Atrophy .....	906
Banti's Disease (Spleen) .....	5017
Basedow's Disease .....	30665
Bechterew's Disease (Spondylitis Deformans) .....	9079
Bell's Paralysis .....	5043
Benign Tumors .....	501
Bilious Fever .....	1032
Biliousness .....	4057
Bladder, Hernia .....	104862
Bleeding Gums .....	40959591
Blocked Nerves .....	9063
Blood Clot .....	80799
Blood Sugar .....	4095
Bloody Flux .....	40910
Botulism .....	60179
Brill's Disease (Typhus Fever) .....	70936
Bronchial Irritation .....	809984

Actino Mycosis 6049

(probable)

Aids 50743 + remedy  
Salyrgen through  
lymphothymus (327-396)  
Also drink BASIL tea.

Constipation - 4057 + 49638 casara

# Type 4 Cancer - 50-9-7-8

## Diseases - Continued

Broncho-pneumonia .....	8024
Bruises .....	209
Burns (1st Degree) .....	7092
Burns (2nd Degree) .....	7094
Burns (3rd Degree) .....	7096
Bursitis .....	4028
Caecal Hernia .....	104882
Cancer, Medullary .....	50974
Cancer, Melanotic .....	70198
Cancer, Scirrhus .....	70194
Cancer Toxins .....	309
Canker Sore .....	7029101
(Canker sore due to 402 in 32; also 407 in 22 and pancreas; also 901547 in 32.)	
Carotid Aneurysm .....	40894
Caruncle, Urethra .....	10058
Catarrh .....	602
Cervicodorsal Neuralgia .....	7024
Chancre .....	5052
Chanchroid .....	5054
Chicken-pox .....	6093
Chloasma .....	8047
Choking .....	90682
Cholelithiasis .....	20438
Collapse .....	90788
Contraction of Fascia .....	1024
Contracture .....	10101
Contusions .....	90101
Cough .....	9068
Cramp .....	702223
Dandruff .....	1062
Dermatoid Cyst .....	60178
Diarrhoea, Acid .....	7064
Diarrhoea, Amoeba Dysenterica .....	6093
Dilation .....	3065
Diplopia (Strabismus) .....	30971
Dislocation .....	8069
Distemper .....	601042
Diverticula of Esophagus .....	80610
Dropsy .....	6012
Ear Wax .....	406
Fatigue, Mental .....	3067
Fear .....	7031
Felon .....	8057
Fibroma .....	501
Flea Bite .....	4
Fluid (anywhere) .....	601
Gangrene .....	20777
Granuloma Coccidioides .....	40174
Gums, Bleeding .....	40959591
Gums, Receding .....	408111
Haemorrhage, Arrest .....	70393
(To arrest haemorrhage normalize parathyroids.)	

Fever  
(undulant)  
90-7-4

glanders (Farc.) = - 6049

**Diseases—Continued**

Hernia, Abdominal .....	104859
Hernia, Bladder .....	104862
Hernia, Caecal .....	104882
Hernia, Femoral .....	104849
Hernia, Inguinal .....	104845
Hernia, Strangulated .....	2091048
Hernia, Ventral .....	104843
Hiccough (Nerve, Phrenic) .....	1001096
Hiccough (Blocked Nerve to Epiglottis) .....	9063277
Hiccough (Inflammation of Pleura and Lung) .....	40776
Hiccough (Nerve to Pleura) .....	90117
Host to Syphilis .....	8044
Hot flashes, due to Sympathetic Nervous System (to Normalize) .....	70399
Hypertrophy .....	8040
Ichthyosis .....	307101
Impinged Nerves .....	9063
Insomnia .....	80573
Intra-cerebellar Pressure .....	10694
Intra-cerebral Pressure .....	10682
Intra-ocular Pressure .....	10280
Itching .....	90172
Kala-azar Infantile (Leishman's Ponsvani—also called Ponos) .....	359
Kidney, Large White .....	601379 (or 3719)
Kidney, Small White .....	60110101379 (or 3719)
Lie (Falsehood) .....	7077
Lipoma .....	2044
Malignancy .....	10722
Meningo Coccus .....	1042
Menstruation, Delayed .....	1041
Multiple Sclerosis (of Dorsal Region of Meninges) .....	901922
Multiple Sclerosis (of Lumbo-sacral Region) .....	9019221
Numbness .....	7074
Numbness in Arms .....	80579366
Numbness in legs .....	90774295
Nymphomania .....	8097462
Obsession, Elemental .....	9012
Obsession, Entity .....	4068792
Obsession, Habit .....	60834
Paralysis, Cerebral .....	4024
Paralysis, Facial .....	50421029
Parasites .....	1088
Parasites, Animal .....	1088103
Parasites, Fruit .....	1088146
Parasites, Human .....	1088119
Parasites, Vegetable .....	1088126
Parasitosis .....	9043
Parasitosis and Ova .....	9077
Pellagra, Intestinal .....	60422
Pellagra, Mental (Brain) .....	6041332
Pellagra, Skin .....	604101

**Diseases—Continued**

Perforation .....	406
Pertussis .....	10343
Pneumonia, Broncho .....	8024
Poison Ivy .....	1034
Poison Oak .....	10188
Poison Sumac .....	10085
Pressure, Intra-cerebral .....	10682
Pressure, Intra-cerebellar .....	10694
Pressure, Intra-ocular .....	10280
Prolapsus of Organs.....	8087
Psora .....	408
Pterygium .....	10994
Pus (in teeth).....	1028
Pus, Malignant .....	40567
Pyorrhoea .....	408591
Rabies .....	10975
Radium Burn .....	8049
Ranula .....	8094
Receding Gums .....	408111
Ring-worm .....	8071
Scarlet Fever .....	10314
Scar Tissue .....	101
Sneezing .....	6023
Spider Bite .....	9011886
Staphylococcus .....	304
Stone in Gall Bladder.....	20438
Streptococcus .....	60
Swelling .....	401
Syphilis, Mexican .....	509
Tenia .....	8046
Thrombus .....	7068
Toxins (all Diseases) .....	6065
" Alcohol .....	3028
" Anger .....	3078
" Brain .....	30397
" Candy .....	8090
" Carbohydrates .....	5053
" Carcinoma .....	309
" Chicken-pox .....	6093
" Destroyed (inactive) .....	10489
" Diphtheria .....	206233
" Fatigue .....	3067
" Fats .....	6033
" Foods .....	7063
" Hate .....	8093
" Influenza .....	308104
" Lesion .....	10993
" Lues, Congenital .....	10192
" Malaria .....	30283
" Measles .....	10833
" Measles, German .....	10243
" Mumps .....	10173
" Pertussis .....	10673

Shingles (HERPES ZOSTER) P.27-



**Diseases—Continued**

"	Pneumonia .....	406183
"	Proteids .....	6073
"	Serums .....	40698
"	Small-pox .....	403
"	Streptococcus .....	6042
"	Typhoid .....	203143
"	Vaccine .....	10497
"	Venereal .....	40699
"	White Sugar .....	10493
Trench Mouth .....		20994
Tuberculosis (Cryptogenic) .....		402
"	Acquired (Human) .....	40215
"	Animal Parasite .....	4026
"	Avian .....	40223
"	(coming from cow's milk, or after vaccination) .....	40257
"	(coming from pollen (25) found on erigeron and often complicating hay fever) .....	40277
"	Fruit or Vegetable .....	4022
"	Inherited .....	4025
Tularemia .....		40833
Tumefaction .....		30785
Tumor, Serofibrinous .....		60104
Ulcer .....		30
Ulcerated Teeth .....		30449
Urethral Caruncle .....		10058
Uric Acid .....		506
	(This put through kidneys increases urine)	
Varicose Veins .....		2034
Warts .....		10972
Tape—Worms .....		9080
Worms, Animal .....		1046
Worms, Fluke .....		1003
Worms, Pin .....		102
X-Ray Burn .....		60578

Tape—  
907980

Undulant Fever -

9074

# DISEASES AND THEIR CAUSES

## MENSTRUATION

### Amenorrhoea

Acromegaly .....	309694
Addison's Disease .....	50112
Alcoholism, Chronic .....	9014004
Anaemia .....	20976
Anorexia Nervosa .....	40132
Atrophy of Uterus .....	906954
Cervical Catarrh .....	9052602
Chlorosis .....	40954093
Colitis .....	6021
Diabetes	
Insipidus .....	5092
Mellitus .....	5094
Ectopic Gestation .....	60239973 (or 2)
Endometritis .....	907651
Enteric Fever .....	709222
Exophthalmic Goitre .....	30665
Fibroids .....	501
Hysteria .....	70936
Lead-poisoning .....	9011609
Leukaemia .....	401465
Lymphadenoma .....	302758
Melancholia .....	10976
Mercurialism .....	9017046
Metritis .....	407651
Morphinism .....	9014056
Nephritis, Chronic .....	4037 (or 371)
Obesity .....	50699
Oophoritis .....	40338 (or 4)
Ovarian Cysts, Double .....	601338 (or 4)
Parametritis .....	40954
Pelvic Adhesions .....	5025101
Phthisis .....	40277 (or 76)
Renal Insufficiency .....	20737 (or 371)
Rheumatism, Acute of Nerve .....	702
Scarlatina .....	10743
Superinvolution .....	9065954
Tuberculous Kidney .....	40237 (or 371)
Ulcer of Stomach .....	30321

### Dysmenorrhoea

Anaemia .....	20976
Anteflexion .....	90547
Cancer .....	50
Cervix, Long Conical .....	501 (or 508) 952
Chlorosis .....	4095
Congestion, Uterine .....	40149954
Ectopic Gestation .....	60239973 (or 2)
Endometritis .....	907651
Fibroids, Uterine .....	501954 (or 952)
Gout .....	502119
Hypertrophy of Uterus .....	401954
Neuralgia .....	80864

Obstruction .....	501 (or 508) 954
Oophoritis .....	40338 (or 334)
Ovary, Small Cystic.....	601338 (or 334)
Peritonitis, Pelvic .....	401653252
Polypus, Uterus .....	30795197
Retroflexion .....	90542
Retroversion .....	90548
Rheumatism .....	704
Salpingitis .....	502973 (or 2)
Stenosis of Canal.....	207952

**Menorrhagia and Metrorrhagia**

Abortion .....	90764954
Adenoma Internum .....	90126954
Alcoholism .....	9014004
Anteflexion .....	90547
Cancer of Uterus.....	50954 (or 952)
Chlorosis .....	4095
Cirrhosis of Liver.....	109148
Congestion of Uterus.....	401954
Ectopic Gestation .....	60239973
Endometritis .....	907651
Exophthalmic Goitre .....	30665
Fibroids .....	501
Granular Os .....	502952
Haematocele .....	409788 (or 781)
Haemophilia .....	4096
Heart Disease .....	4025
Hypertrophy of Uterus.....	401954
Inversion .....	4035954
Lead-poisoning .....	9011609
Leukaemia .....	401465
Malaria .....	302 04
Menopause .....	10
Metritis .....	407651
Miscarriage .....	10937 (or 4035)
Nephritis .....	4037 (or 371)
Oophoritis .....	40338 (or 334)
Ovaries, Displaced .....	4035338 (or 334)
Ovarian Growths .....	601338 (or 334)
Pelvic Cellulitis .....	40954101
Pelvic Peritonitis .....	401653252
Phosphorus-poisoning .....	901695
Polypus .....	30795197
Prolapsus Uteri .....	8087954
Purpura .....	10427101
Pyometra .....	60954
Retroflexion .....	90542
Retroversion .....	90548
Salpingitis .....	502973 (or 2)
Sarcoma .....	508954
Scurvy .....	108749
Subinvolution .....	7065954
Syphilis .....	505954
Uterus, Tuberculosis of.....	402954

3283 →

Vaginitis, Senile Granular.....	402095
Variola, Malignant .....	403101
Yellow Atrophy, Acute.....	2044048 (or 487)

**Dyspareunia**

Anal Fissure .....	706851
Bartholinitis .....	30293 (or 311)
Caruncle .....	40101
Cystitis .....	6062
Gonorrhoea .....	502
Haemorrhoids	
Internal .....	2015
External .....	2096
Hymeneal Orifice, Inflamed.....	40695
Labial Oedema .....	6016101 (or 6103)
Metritis .....	407651
Neuritis, Pudic .....	70511165
Oophoritis, Adhesive.....	101338 (or 334)
Ovary, Prolapsed.....	8087338 (or 334)
Perinaeal Laceration .....	403558
Urethritis .....	40439
Vaginismus .....	2074095
Vulvitis .....	40258

**DISCHARGES**

**VAGINAL DISCHARGES**

<b>White Discharge (Leukorrhoea)</b> .....	3071336 (or 332)
Anaemia .....	20976
Anteflexion .....	90547
Bartholinitis .....	30293 (or 311)
Cervical Catarrh .....	9052602
Endometritis, Chronic .....	907651
Erosions, Cervical .....	502952
Fibroid Tumors .....	50195
Gonorrhoea .....	502
Granular Cervix .....	502952
Hypertrophied Cervix .....	401952
Metritis, Chronic .....	407651
Pelvic Peritonitis .....	401653252
Polypus Vagina .....	3075195
Prolapsus Uteri .....	8087954
Salpingitis .....	502973 (or 2)
Sarcoma of Uterus.....	508954
Tubal Colic .....	502973 (or 2)
Vaginitis, Catarrhal .....	6095
Vaginitis, Granular .....	402095
Worms .....	9080
<b>Sanguineo-purulent Discharge</b>	
Cancer of Uterus.....	50954
Endometritis, Haemorrhagic .....	10427954
Endometritis, Purulent .....	6097651
Endometritis, Senile .....	2097651
Endometritis, Septic .....	60954

*Trichomonas (Vaginal) 90837(95)*

Metritis, Acute .....	407651
Pelvic Abscess .....	302525
Polypus .....	3075195
<b>Offensive Discharge</b>	
Abscess, Pelvic .....	302525
Cancer of Uterus.....	50954
Death of Foetus.....	504379
Endometritis, Chronic .....	907651
Endometritis, Senile .....	2097651
Endometritis, Septic .....	60954
Fibroids, Cervical .....	501952
<b>Shreds and Membranes</b>	
Abortion .....	90764954
Diphtheria .....	20932
Ectopic Gestation .....	60239973 (or 2)
Membranous Dysmenorrhoea .....	50667101
Miscarriage .....	10937 (or 4035)
<b>Emission of Gas</b>	
Recto-Vaginal Fistula.....	706851 (or 95)

## PAIN

### GENERAL PAIN

Anaemia .....	20976
Anterior Poliomyelitis, Acute.....	40865
Diabetes	
Insipidus .....	5092
Mellitus .....	5094
Fevers .....	709
"Growing Pains" .....	507910
Cout .....	502119
Infantile Scurvy .....	108749
Influenza .....	308
Lead-poisoning .....	9011609
Lithaemia .....	407
Locomotor Ataxy .....	50592
Meningitis, Spinal .....	40279
Nephritis, Chronic .....	4037 (or 371)
Osteomalacia .....	402847
Periarteritis Nodosa .....	4049758
Rheumatism .....	704
Scurvy .....	108749
Syphilis .....	505
Trichinosis .....	90837

### REGIONAL PAIN

#### Frontal Headache

Adenoids .....	90138
Anaemia .....	20976
Enteric Fever .....	709222
Eyestrain .....	501647
Fevers .....	709
Frontal Sinus Obstruction.....	606133

Gastritis .....	40321
Glaucoma .....	40269
Haemotoma of Dura Mater.....	80799279
Iritis .....	402534
Lithaemia .....	407
Malaria .....	302
Neurasthenia .....	40739
Periostitis .....	40359
Syphilitic Nodes .....	505889
Thrombosis of Sup. Long. Sinus.....	90768975
Trigeminal Neuralgia .....	808642285
Uraemia .....	50637371

### Occipital Headache

Adenoids .....	90138
Cerebral Tumors .....	501 (or 508) 29 (or 291)
Cerebro-spinal Meningitis.....	4027929 (or 291)
Cervico-occipital Neuralgia .....	90274
Cirrhosis (of Kidney).....	109123
Constipation .....	7029
Diabetes	
Insipidus .....	5092
Mellitus .....	5094
Epilepsy .....	2092
Eyestrain .....	501647
Gout .....	502119
Locomotor Ataxy .....	50521
Naso-pharyngeal Disease .....	901389619
Nephritis, Chronic .....	4037 (or 371)
Neurasthenia .....	40739
Pharyngitis .....	4019
Rheumatism .....	704
Sphenoidal Disease .....	60284993
Syphilis .....	505
Syringomyelia .....	40297
Tongue Lesions, Basal.....	5081296
Uterine Diseases .....	40954

### Unilateral Headache

Adenoids .....	90138
Antral Abscess .....	302254
Bone, Diseased .....	40284
Cancer of Tongue.....	501296
Carious Teeth .....	5024
Dysmenorrhoea .....	70101
Eyestrain, Unilateral .....	501647 (or 1)
Gouty State .....	502119
Hysteria .....	70936
Mastoid Abscess .....	602843
Migraine Headache .....	70964
Nephritis, Chronic .....	4037 (or 371)
Otitis Media .....	6013372
Polypus, Nasal .....	3075196
Trigeminal Neuralgia .....	808642285
Tumor, Cerebral .....	501 (or 508) 29 (or 291)
Wax in Meatus.....	40613372

Anaemia .....	20976
Chlorosis .....	4095
Constipation .....	7029
Epilepsy .....	2092
Hysteria .....	70936
Neurasthenia .....	40739

### Unclassified Headaches

Abscess of Brain.....	30244
Addison's Disease .....	50112
Ague .....	30248709
Alcoholism .....	9014004
Amenorrhoea .....	801954
Anaemia .....	20976
Apoplexy .....	903
Arsenic-poisoning .....	901656
Asthma .....	70949
Atony of Stomach.....	107832
Aura Epileptica .....	2092
Catalepsy .....	90798
Chlorosis .....	4095
Cirrhosis of Kidney.....	109137 (or 371)
Compression of Brain.....	106821332
Congestion of Liver.....	40148
Constipation .....	7029
Coryza .....	904681
Diabetes	
Insipidus .....	5092
Mellitus .....	5094
Dilatation of Stomach.....	306532
Disseminated Sclerosis .....	90192
Duodenal Catarrh .....	60221
Dysmenorrhoea .....	70101
Dyspepsia .....	608
Dyspnoea .....	207494734
Embolism, Cerebral .....	90749
Encephalitis .....	401332
Epilepsy .....	2092
Erysipelas .....	70798
Exophthalmic Goitre .....	30665
General Paralysis .....	5042
Glandular Fever .....	709327
Glaucoma .....	40269
Gouty State .....	502119
Haematoma of Dura Mater.....	80799279
Haemorrhage .....	10427
Hay Fever .....	6096
Hereditary Cerebellar Ataxy.....	5079244
Hydrocephalus .....	10821
Hyperaemia of Brain.....	409411332
Hypertrophy of Brain.....	4011332
Hypertrophy of Heart.....	40125
Hysteria .....	70936
Influenza .....	308
Iritis .....	402534

Jaundice .....	40811
Lead-poisoning .....	9011609
Leukorrhoea .....	3071336 (or 332)
Lithaemia .....	407
Measles .....	10322
Measles, German .....	10374
Meningitis .....	40279
Meningitis, Cerebro-spinal.....	4029 (or 291) 279
Menopause .....	10
Mental Overstrain .....	9074
Morphinism .....	4056
Nephritis .....	4037 (or 371)
Neuralgia .....	80864
Neurasthenia .....	40739
Oophoritis .....	40338 (or 334)
Oxaluria .....	609252
Pachymeningitis .....	402791
Pneumonia, Acute .....	2017
Polycythaemia, Splenomegalic .....	401465
Polypus, Nasal .....	3075196
Pyrexia .....	709
Rheumatism .....	704
Softening of Brain.....	6011332
Spur of Septum.....	50115496
Sunstroke .....	407279
Syphilis .....	505
Tapeworm .....	907980
Tension, High Arterial.....	40904947
Thrombosis, Cerebral .....	909829
Tumor of Brain.....	5011332
Turbinated Bone, Enlarged.....	40115496
Typhus .....	709222
Uraemia .....	50637371
Valvular Disease .....	501256 (or 259)
Variola .....	403101
Weil's Disease .....	40118848

### **Eyeballs**

Conjunctivitis .....	7041
Coryza .....	904681
Eyestrain .....	501647
Glaucoma .....	40269
Injuries .....	10923 (or 31)
Iritis .....	402534
Keratitis .....	303988
Migraine (Headache) .....	70964
Neuralgia of Fifth Nerve.....	808642285
Ophthalmoplegia Interna .....	50425993 (or 31)
Panophthalmia .....	403 (or 31)
Sphenoidal Sinusitis .....	60133

### **Earache**

Abscess, Alveolar .....	302499
Abscess, Mastoid .....	602843
Anaemia .....	20976
Aneurysm of Innominate.....	40149744



**Upper Jaw**

Abscess, Alveolar .....	302499
Abscess of Pulp.....	30251499
Antrum, Disease of.....	60254
Cancer .....	5084864
←Caries .....	5024864
Exostosis, Dental .....	3084864
Neuralgia, Sup. Max.....	808641029
Periodontitis .....	40591
Periostitis .....	40359
Pulpitis .....	4051499
Salivary Calculus .....	204589

**Lower Jaw**

Abscess, Alveolar .....	302499
Abscess of Pulp.....	30251499
Actinomycosis .....	6049
Caries .....	5024
Exostosis, Dental .....	3084499
Fracture .....	907872
Mumps .....	10327
Neuralgia, Inf. Max.....	80864872
Periodontitis .....	40591
Pulpitis .....	4051499
Salivary Calculus .....	204589

**Neck**

Abscess .....	302523
Caries, Cervical .....	502444
Glandular Fever .....	709327
Caries of Temporal Bone.....	50284862
Chloroma .....	50277784
Eczema of Meatus.....	305313372
Foreign Body in Meatus.....	1047413372
Furuncle in Meatus.....	409213372
Gland, Inflamed Mastoid.....	602843
Herpes Auris .....	6024013372
Injuries .....	10929 (or 91)
Larynx, Ulcer of.....	3017
Mastoiditis .....	602843
Mumps .....	10327
Neuralgia, Trigeminal .....	808642285
Otitis Media or Interna, Acute.....	6013372
Perichondritis, Acute .....	40154
Pharynx, Ulcerated .....	3019
Polypus .....	307519 (or 91)
Pulpitis, Dental .....	4051499
Rheumatism, Temporomaxillary .....	902862864
Sphenoidal Sinusitis .....	602133
Tongue, Cancer of.....	501296
Tongue, Ulcer of.....	301296
Toxaemia .....	60659 (or 91)

**Nose**

Antral Disease .....	90138
Foreign Body .....	1047496
Frontal Empyema .....	602596

Glanders .....	6049
Syphilis .....	505
Innominate Aneurysm .....	40149744
Lymphadenoma .....	302758
Polymyositis .....	40599
Rheumatism .....	704
Strain .....	6093865
Syringomyelia .....	40297

### **Nape of Neck (Nucha)**

Cerebellar Disease .....	401332
Cerebro-spinal Meningitis .....	4027929 (or 291)
Cervico-occipital Neuralgia .....	90274
Muscles, Sprained .....	40599
Neurasthenia .....	40739
Pharyngitis .....	40198
Rheumatism .....	704
Spinal Meningeal Haemorrhage.....	10427279
Tetanus .....	30785

### **Throat**

Cancer .....	50966
Concretions in Tonsil.....	60206 (or 61)
Crico-arytenoid Arthritis .....	4049710909
Diphtheria .....	20932
Foreign Body .....	10474966
Laryngitis .....	4017
Naso-pharyngeal Catarrh .....	60296198
Pharyngitis .....	40198
Poisoning by	
Aconite .....	901558
Cantharides .....	9011026
Conium .....	9015239
Corrosives .....	90140517
Irritants .....	90148
Post-pharyngeal Abscess .....	302198
Quinsy .....	6026 (or 61)---
Scarlatina .....	10743
Tonsillitis .....	40476--
Tuberculous Pharyngitis .....	40240198
Tuberculous Tonsillitis .....	4026 (or 61)
Uvula, Swollen .....	401258

## **PAIN IN BACK**

### **Spinal Pain**

Apoplexy, Spinal .....	903279
Aneurysm, Abdominal .....	4014971233
Aneurysm of Descending Aorta.....	4014977898
Cancer of Liver.....	5048 (or 487)
Cancer of Spine.....	50297
Caries of Vertebrae.....	5024867
Cerebro-spinal Meningitis .....	4027929 (or 291)
Compression of Cord.....	90192297
Disseminated Sclerosis .....	90192297
External Spinal Pachymeningitis.....	402791297
Hyperaemia of Cord.....	409297

Hysteria .....	70936
Meningitis, Internal Spinal.....	40297
Mollities Ossium .....	60134533
Myelitis .....	40599
Neuralgia .....	80864
Neurasthenia .....	40739
Osteomyelitis .....	4084599
Osteitis Deformans .....	5015119428
Rheumatoid Arthritis .....	9027
Salpingitis .....	502973 (or 2)
Spinal Meningeal Haemorrhage.....	10427279
Sprains .....	70599279
Syringomyelia .....	40297
Traumatic Spondylitis .....	1092297
Tuberculous Spinal Meningitis.....	402279
Tumor of Cord.....	508297
Ulcer of Stomach.....	30321

### Coccygeal Pain

Fissure of Anus.....	706851
Fistula .....	30-7-6 706
Haemorrhoids	
Internal .....	2015
External .....	2096
Injuries .....	1092188
Periproctitis .....	40851
Rheumatism .....	704
Sacro-coccygeal Tuberculosis .....	402854188
Uterine Diseases .....	40954

### Sacral Pain

Ataxic Paraplegia .....	50592
Cancer of Rectum, Uterus, or Testis	
50851 (or 954) (or 781) (or 788)	
Cervical Catarrh .....	602952
Dysmenorrhoea .....	70101
Endometritis .....	907651
Fibroids .....	501954
Flexions of Uterus.....	4035954
Haemorrhoids	
Internal .....	2015
External .....	2096
Hip Disease .....	4021775
Inversion of Uterus.....	4035954
Metritis .....	907651
Neuralgia .....	80864
Orchitis .....	40788 (or 781)
Ovarian Disease .....	40338 (or 334)
Pelvic Peritonitis .....	401653252
Prolapsus Uteri .....	8087954
Retroversion .....	90548
Sacro-iliac Disease .....	402854374 (or 2)
Salpingitis .....	502973
Sarcoma of Uterus.....	508954
Scybala .....	8026127
Spinal Apoplexy .....	903279

Subinvolution .....	7065954
Tumors of Uterus.....	501 (or 508) 954

### Lumbar Pain

Abscess, Lumbar .....	302987
Abscess, Perinaeal .....	3021653
Abscess, Rectal .....	50851
Aneurysm, Abdominal .....	4014971233
Appendicitis .....	6072
Calculus, Renal .....	2094
Calculus, Vesical .....	209462
Cancer of Spine.....	50297
Cancer of Stomach.....	50321
Caries of Spine.....	5024297
Cauda Equina, Tumor of.....	50821
Chorea .....	10393
Chyluria .....	908969
Curvature, Lateral.....	7052 (right) 70521 (left)
Cystitis .....	6062
"Diabetes, Phosphatic" .....	5094254
Dysmenorrhoea .....	70101
Embolism, Renal .....	407923
Enteroptosis .....	808722
Faecal Accumulation .....	7029
Fatigue .....	8069
Flatulence .....	6078927
Gravel .....	20 (or 56)
Hernia .....	104843
Hydatids .....	30291
Hydronephrosis .....	60123
Infantile Paralysis .....	20692
Influenza .....	308
Kidney, Floating .....	403537 (or 371)
Kidney, Tuberculous .....	40237 (or 371)
Kidney, Cancer of.....	5037 (or 371)
Lithaemia .....	407
Locomotor Ataxia .....	50592
Lumbago .....	40599193
Meningitis, Internal Spinal.....	40279
Meningitis, Tuberculous Spinal.....	402297
Miscarriage .....	10937 (or 4035)
Nephralgia .....	7037 (or 371)
Nephritis, Acute .....	4037371
Nephritis, Suppurating .....	6037371
Neuralgia, Lumbo-abdominal .....	80864193
Neurasthenia .....	40739
Oophoritis .....	40338 (or 334)
Pachymeningitis, External Spinal.....	402791
Parasite of Kidney.....	108837 (or 371)
Perinephritis .....	40379 (or 3719)
Pleurisy .....	407 (or 71)
Polycythaemia, Splenomegalic .....	401465
Prostatitis .....	40999
Pyelitis .....	6037 (or 371)
Pyonephrosis .....	60237 (or 371)

Retroflexion .....	90542
Thrombosis, Renal .....	909823
Tumor, Abdominal .....	501 (or 508) 1233
Typhoid Spine .....	203143279
Variola .....	403101

### Interscapular Pain

Aneurysm of Descending Aorta.....	4014977898
Atony of Stomach.....	107832
Cancer of Stomach.....	50321
Caries of Dorsal Spine.....	5024183
Cerebellar Tumor .....	501 (or 508) 231
Cirrhosis of Stomach.....	109132
Flatulence .....	6078927
Gastric Irritation .....	4032
Gastric Ulcer .....	3032
Gastritis .....	40321
Mediastinal Abscess .....	302356
Mediastinal Tumor .....	501 (or 508) 356
Rheumatism .....	704
Tumor of Cord.....	508297

## PAIN IN CHEST

### Mamma

Abscess, Mammary .....	30273 (or 74)
Abscess, Retromammary .....	302738 (or 748)
Abscess, Tuberculous .....	40273 (or 74)
Cancer .....	5073 (or 74)
Cracked Nipple .....	1010194
Cyst, Multiple .....	10691
Ectopic Gestation .....	60239973
Hysteria .....	70936
Lobular Induration .....	50173 (or 74)
Mastitis, Chronic .....	4073 (or 74)
Menstruation .....	8014
Neuralgia .....	8086473 (or 74)
Obstructed Lacteal Duct.....	1024333
Ovarian Disease .....	40338 (or 334)
Pregnancy .....	60239

### Sternum

Aneurysm, Thoracic .....	40149775
Angina Pectoris .....	7025
Aortitis .....	407898
Bronchial Calculus .....	2042392
Bronchial Glands, Enlarged.....	8054
Bronchitis, Acute .....	402392
Caries of Sternum or Spine.....	5024263 (or 297)
Foreign Body in Lungs.....	1047476 (or 77)
Gastric Irritation .....	4032
Influenza .....	308
Locomotor Ataxia .....	50592
Mediastinal Abscess .....	302356
Mediastinal Tumor.....	501 (or 508) 356
Oesophagismus .....	20735

Spinal Apoplexy .....903279  
 Syphilis .....505

**Pericardium**

Anaemia .....20976  
 Aneurysm .....401497  
 Aneurysm of Heart.....40149725  
 Angina Pectoris .....7025  
 Aortic Cusp, Rupture of.....1092256 (or 9)  
 Aortic Regurgitation .....402256  
 Arsenic-poisoning .....901656  
 Endocarditis .....403795  
 Epilepsy .....2092  
 Fibroid Disease of Heart.....50125  
 Flatulence .....6078927  
 Functioning Heart Disorder.....708987  
 Gastritis .....40321  
 Gastralgia .....40222  
 Gout .....502119  
 Heartburn .....407321  
 Heartstrain .....609386525  
 Hysteria .....70936  
 Myocarditis, Acute .....405992572  
 Pericarditis .....402587  
 Pseudangina .....4081  
 Syphilitic Heart .....50525  
 Thrombosis of Pulmonary Artery.....9009534-9098  
 Valvular Disease.....501256 (or 251)

**Pain in Side**

Caries of Spine.....5024297  
 Cholecystitis .....20438  
 Faecal Accumulation .....7029  
 Flatulence .....6078927  
 Fracture of Spine.....90784297  
 Herpes Zoster .....60240101542  
 Hysteria .....70936  
 Intercostal Rheumatism .....704542  
 Intercostal Neuralgia .....702542  
 Pleura, Cancer of.....507 (or 5071)  
 Pleurisy, Acute .....407 (or 4071)  
 Pneumonia, Acute .....2017  
 Pneumothorax .....1092675  
 Ribs, Carious .....5024542  
 Ribs, Fractured .....907542

*shingles* -

**Right Hypochondrium or Pain over Liver**

Abscess, Hepatic .....304248  
 Abscess, Perinephric .....30223379 (or 3719)  
 Abscess, Subphrenic .....505991096  
 Cancer of Colon.....5027  
 Cancer of Duodenum.....50221  
 Cancer of Liver.....5048 (or 487)  
 Cancer of Pancreas.....50997 (or 9972)  
 Cancer of Pylorus.....50321  
 Cancer of Stomach.....5032

Cholecystitis .....	20438
Cirrhosis of Liver.....	109148
Colic, Right Renal.....	209437
Constricted Liver .....	1010148
Cyanotic Liver .....	1010148748
Empyema of Gall-bladder.....	6038 -
Gallstones .....	20438
Hepatitis, Acute .....	4048
Herpes Zoster .....	60240101542
Hydatids, Inflamed .....	30291
Movable Kidney .....	20387
Neuralgia, Intercostal .....	702542
Periarteritis Nodosa .....	4049758
Perihepatitis .....	4056648
Peritonitis .....	401653
Pleurisy .....	407 (or 71)
Pneumonia .....	2017
Sprain .....	70599
Syphilitic Liver .....	50548
Ulcer, Duodenal .....	30221
Yellow Atrophy, Acute.....	2044048 (or 487)

#### Left Hypochondrium

Abscess, Perinephric .....	30223379 (or 3719)
Abscess, Subphrenic .....	505991096
Anaemia .....	20976
Aneurysm, Abdominal .....	4014971233
Cancer of Colon.....	5027
Cancer of Stomach.....	50321
Colitis .....	30127
Faecal Accumulation .....	7029
Gastric Catarrh .....	6032 60232
Gastroptosis .....	808732
Herpes Zoster .....	60240101542
Malaria .....	302
Movable Kidney .....	20387
Neuralgia, Intercostal .....	702542
Peritonitis .....	401653
Pleurisy .....	407 (or 71)
Renal Colic .....	209437 (or 371)
Spleen, Enlarged .....	401465
Splenic Infarct .....	10427465
Ulcer of Stomach.....	30321

#### Unclassified Chest Pain

Abscess, Mediastinal .....	302356
Aneurysm .....	401497
Atony of Stomach.....	107832
Bronchitis, Chronic .....	6024
Cancer of Lung.....	5077 (or 76)
Diaphragm, Neuralgia of.....	80864844
Dyspepsia .....	608
Emphysema of Lung.....	60277 (or 76)
Herpes Zoster .....	60240101542
Mollities Ossium .....	6013453
Myalgia .....	40599

Neurofibromata .....	5011109
Phthisis, Acute .....	40277 (or 76)
Pneumothorax .....	1092675
Pulmonary Embolism .....	407977 (or 76)
Rheumatism .....	704
Sprained Pectorals .....	70746
Syphilitic Periostitis .....	505359
Tumor of Mediastinum .....	501 (or 508) 356

## PAIN IN ABDOMEN

### Epigastrium or Pit of Stomach

Abdominal Angina .....	701233
Abscess, Subphrenic .....	505991096
Acute Yellow Atrophy.....	2044048 (or 487)
Addison's Disease .....	50112
Aneurysm, Abdominal .....	4014971233
Appendicitis Larvata .....	607898
Arsenic-poisoning .....	901656
Atony of Stomach.....	107832
Cancer of Pancreas .....	50997
Cancer of Pylorus.....	50321
Cancer of Stomach.....	5032
Caries of Spine.....	5024297
Cholecystitis, Acute .....	20438
Cholera, Asiatic .....	90118822
Cirrhosis of Stomach.....	109132
Dilated Right Ventricle.....	3065259
Dilatation of Stomach.....	306532
Distended Trans. Colon.....	306583
Enteroptosis .....	808722
Gallstones .....	20438
"Gout of Stomach".....	50232
Gastric Irritation .....	4032
Gastralgia .....	40222
Gastro-Intestinal Adhesions .....	1013222
Gastro-Cholecystic Adhesions .....	1013238
Gastritis, Acute Erythematous.....	40732
Gastritis, Chronic .....	4032
Hepatoptosis .....	808748
Hernia, Small Epigastric.....	104843
Hyperchlorhydria .....	8032110
Intercostal Neuralgia .....	702542
Irritant-poisoning .....	90148
Liver, Abscess of.....	304248 (or 487) -acute
Liver, Cancer of.....	5048 (or 487)
Liver Cyanotic .....	1010149748
Locomotor Ataxy .....	50592
Pancreas, Cancer of.....	50997
Pancreatic Calculus .....	204997
Pancreatitis, Acute .....	40997
Pericarditis .....	402587
Perihepatitis .....	4056648
Pleurisy, Diaphragmatic .....	4078044



Pneumonia .....	2017
- Strain of Recti Muscles.....	6093865851
Thrombosis, Pulmonary .....	909877 (or 76)
Ulcer of Duodenum.....	30221
Ulcer of Stomach.....	30321
<b>Umbilicus</b>	
Abscess, Peritoneal .....	3021653
Cancer of Colon.....	5027
Cyst, Sebaceous .....	601101
Gallstones .....	20438
Gastric Ulcer .....	30321
Hernia .....	104859
Omental Cancer .....	504334
Oophoritis .....	40338 (or 334)
Spine, Caries of.....	5024297
Recti, Divarication of.....	8069851
<b>Hypogastrium and Pelvis</b>	
Amenorrhoea .....	801954
Bladder, Cancer of.....	5062
Bladder, Distended .....	306562
Bladder, Tubercle of.....	40262
Bladder, Ulcer of.....	3062
Calculus .....	209462
Cancer of Uterus.....	50954
Chyluria .....	908969
Cystitis .....	6062
Dysmenorrhoea .....	70101
Endometritis, Chronic .....	907651
Endometritis, Gonorrhoeal .....	502954
Endometritis, Haemorrhagic .....	10427954
Endometritis, Septic .....	60954
Fibroid, Uterine .....	501954
Hypertrophy of Uterus.....	401954
Inversion of Uterus.....	4035954
Metritis, Acute .....	907651
Mollities Ossium .....	6013453
Neuralgia of Bladder.....	8086462
Neuralgia of Uterus.....	80864954
Oophoritis .....	40338 (or 334)
Pancreatitis .....	40997
Pelvic Abscess .....	30295
Pelvic Haematocele .....	409788 (or 781)
Pelvic Peritonitis .....	401653252
Perforation of Bowel.....	40627
Pericystitis .....	4062
- Phleboliths, Pelvic .....	204494525
Prolapsus Uteri .....	8087954
Pyelitis .....	6037 (or 371)
Retroversion .....	90548
Salpingitis .....	502973 (or 2)
Subinvolution .....	7065954
Tubal Colic .....	502973 (or 2)
Tubal Foetation .....	3079973 (or 2)
Tumor of Cord.....	501 (or 508) 297

**Iliac or Ovarian**

Appendicitis .....	6072 ✓
Caecum Mobile .....	808782
Cancer of Uterus.....	50954
Cervix, Eroded .....	502952
Colitis .....	6021
Diverticulitis .....	40806
Dysmenorrhoea .....	70101
Enteric Fever .....	709222
Floating Rib .....	4035542
Hernia .....	1048
Loaded Caecum .....	109282 (or 72982)
Loaded Sigmoid .....	702985
Neuralgia, Twelfth Dorsal.....	80864212
Neurasthenia .....	40739
Oophoritis .....	40338 (or 334)
Prolapsus Uteri .....	8087954
Renal Calculus .....	209423
Retroflexion .....	90542
Salpingitis .....	502973 (or 2)
Sigmoiditis .....	4085
Ureteral Calculus .....	2094668
Varicocele .....	3068

**Groin, Pain in**

Abscess, Spinal .....	302294 7
Calculus .....	2094
Cancer of Rectum.....	50851
Corn, Inflamed .....	4058442
Haemorrhoids .....	2015 (or 2096)
Hernia, Inguinal .....	104845
Hernia, Obturator Ventral.....	104843
Hernia, Umbilical .....	104859
Meckel's Diverticulitis .....	80627
Ovary, Prolapsed .....	8087338 (or 334)
Polypus, Rectal .....	30751851
Rider's Sprain .....	7059943 (or 42)
Saphenous Varix .....	306549443 (or 42)
Talipes Valgus .....	10937121
Tibia, Old Fracture of.....	907319
Tibia, Osteoma of.....	508319
Testicular Cysts .....	601788 (or 781)
Varicocele .....	3068

**Colic**

Abortion .....	90764954
Appendicular Colic .....	6078
Cancer of Bowel.....	5027
Colitis .....	6021
Diarrhoea .....	60764
Dysentery .....	6093
Food-poisoning .....	901201
Foreign Body in Bowel.....	1047427
Gallstones .....	20438
Henoch's Purpura .....	10427101

Hernia, Strangulated .....	2091048
Hydronephrosis .....	60123
Influenza, Intestinal .....	30822
Intestinal Concretion .....	20422
Intussusception .....	207222
Lead-poisoning .....	9011609
Locomotor Ataxy .....	50592
Neuralgia, Intestinal .....	8086422
Ovarian Cyst .....	601338 (or 334)
Pancreatic Calculus .....	204997
Peritoneal Adhesions .....	1011653
Pyloric Stenosis .....	101321
Renal Calculus .....	209423
Rheumatism, Intestinal .....	70422
Scybala .....	8026127
Uterine Fibroid .....	501954
Ureteral Calculus .....	2092668 (or 6681)

### Unclassified Abdominal Pain

Abscess, Subphrenic .....	505991096
Achylia Gastrica .....	2074632
Aneurysm, Abdominal .....	4014971233
Aortic Regurgitation .....	402256
Cancer, Abdominal .....	501233
Caries, Spinal .....	5024297
Cholera .....	90118822
Colic .....	7027
Colitis .....	6021
Diarrhoea .....	60764
Dyspepsia .....	608
Ectopic Gestation .....	60239973 (or 2)
Embolism of Sup. Mesenteric Artery.....	4079497815
Enteritis .....	4027
Enteroptosis .....	808727 (or 22)
Enterospasm .....	1010122 (or 27)
Faecal Accumulation .....	7029
Foreign Body .....	10474
Gallstones .....	20438
Gastralgia .....	40222
Glands, Inflamed .....	40327
Glandular Fever .....	709327
Henoch's Purpura .....	10427101
Hernia .....	1048
Hernia, Diaphragmatic .....	10488044
Herpes Zoster .....	60240101542
Hydronephrosis .....	60123
Hysteria .....	70936
Ileus .....	7027
Influenza (Gastric form) .....	308321
Intestinal Concretion .....	20422
Intestinal Obstruction .....	6084- ?
Intussusception .....	207222
Irritant-poisoning .....	90148
Kidney, Tuberculous .....	40237 (or 371)

Lead Colic .....	70911609
Leukaemia .....	401465
Locomotor Ataxy .....	50592
Lymphadenoma .....	302758
Meningitis, Spinal .....	40279
Mesenteric Cysts .....	601815
Myalgia .....	40599
Neuralgia, Lumbo-abdominal .....	808641233
Neurasthenia .....	40739
Ovarian Cyst .....	601338 (or 334)
Pancreatic Disease .....	40997
Perforation .....	40627
Periarteritis Nodosa .....	4049758
Pericarditis .....	402587
Peritonitis .....	401653
Pernicious Anaemia .....	50465
Pleurisy, Diaphragmatic .....	4078044
Pneumonia .....	2017
Pneumothorax .....	1092675
Polycythaemia, Splenomegalic .....	401465
Ptomainism .....	901201
Rheumatic Fever .....	604
Rheumatism .....	704
Spinal Tumor .....	508297
Tabes Mesenterica .....	402815
Thrombosis, Mesenteric .....	9098815
Ulcer of Intestine.....	30221

### Perinaeum

Abscess, Ischio-rectal .....	50851835
Abscess, Perineal .....	3023568
Abscess, Prostatic .....	302999
Bartholinitis .....	30293 (or 31)
Bladder, Tuberculosis of.....	40262
Cancer of Bladder.....	5062
Cancer of Prostate.....	50999
Cancer of Rectum.....	50851
Calculus, Prostatic .....	2094979
Calculus, Vesical .....	209462
Condylomata .....	10972851
Cystitis .....	6062
Cystocele .....	601788 (or 781)
Epithelioma, Vaginal .....	40595
Fissure of Anus.....	706851
Fistula .....	30706
Haemorrhoids .....	2015 (or 296)
Locomotor Ataxy .....	50592
Mania .....	6049
Prostate, Adenomatous .....	501101999
Prostate, Tuberculous .....	402999
Prostatitis .....	40999
Rectum, Ulcer of.....	30851
Seminal Vesiculitis .....	402098
Testicle, Perinaeal .....	407883568

Uterine Disease .....	40954
Vaginitis, Acute .....	4095

### Rectum

Abscess, Ischio-rectal .....	302851835
Abscess, Prostatic .....	302999
Cancer of Bladder .....	5062
Cancer of Prostate .....	50999
Cancer of Rectum.....	50851
Cancer of Uterus .....	50954
Colitis, Membranous .....	3061
Condylomata .....	10972851
Cystitis .....	6062
Dysentery .....	6093
Fissure of Anus .....	706851
Fistula .....	30706
Faeces, Impacted .....	608427
Foreign Body .....	10472851
Haemorrhoids .....	2015 (or 2096)
Locomotor Ataxy .....	50592
Neuralgia, Rectal .....	80864851
Perimetritis .....	40954
Salpingitis .....	502973 (or 2)
Ulcer, Rectal .....	30851
Vesiculitis, Seminal .....	402098

### Penis

Bladder, Cancer of.....	5062
Bladder, Tuberculous .....	40262
Bladder, Ulcer of.....	3062
Bladder, Villous Growth of.....	5015862
Calculus, Ureteral .....	2094668
Calculus, Urethral .....	2094439
Calculus, Vesical .....	209462
Cystitis .....	6062
Fissure of Anus.....	706851
Gravel .....	20 (or 506)
Neuralgia .....	80864
Prostate, Abscess of.....	302999
Prostate, Adenomatous .....	501101999
Prostate, Cancer of.....	50999
Prostate, Tuberculous .....	402999
Renal Colic .....	4037 (or 371)
Stone in Ureter.....	2094668 (or 6681)
Stricture .....	407439
Urethral Granulations .....	2094439

### Testicle

Abdominal Aneurysm .....	4014971233
Abdominal Tumor .....	5081233
Calculus, Renal .....	2094
Calculus, Vesical .....	209462
Cancer, Testicle .....	50788 (or 781)
Caries, Lumbar .....	5024193
Colon, Tumor of.....	501 (or 508) 27
Cysts .....	601

Embryoma .....	6013792
Epididymitis .....	407405
Gumma .....	505101
Hernia .....	1048
Haematocele .....	409788 (or 781)
Hydrocele .....	601788 (or 781)
Hydrocele, Encysted .....	10691788 (or 781)
Injury .....	1092788 (or 781)
Neuralgia .....	80864
Nodules in Epididymis .....	50158745
Orchitis .....	40788 (or 781)
Sarcoma Scrotum .....	5082098
Tuberculous Testis .....	402788 (or 781)
Varicocele .....	3068

## PAIN IN LIMBS

### Shoulder

Aneurysm of Innominate .....	40149744
Angina Pectoris .....	7025
Aortic Disease .....	40789
Atony of Stomach .....	1078321
Cancer of Liver .....	5048
Cervico-brachial Neuralgia .....	70599
Colitis .....	6021
Dental Caries .....	50247
Diaphragmatic Pleurisy .....	4078044
Duodenal Catarrh .....	60221
Duodenal Ulcer .....	30221
Fibrositis .....	105
Hepatic Abscess .....	304248
Hepatic Colic .....	6078948
Hepatic Congestion .....	40148
Hepatitis, Acute .....	4048 (or 487)
Mediastinal Tumor .....	508356
Neuritis .....	907651
Pleurisy, Acute .....	407 (or 71)
Pneumonia .....	2017
Progressive Muscular Atrophy .....	906599
Rheumatism .....	704
Synovitis .....	402008
Tumor of Suprarenal Capsule .....	50831072 (or 8)

### Arm

Amytrophic Lat. Sclerosis .....	90192
Aneurysm, Subclavian .....	401497548
Angina Pectoris .....	7025
Atonic Dyspepsia .....	107832
Brachial Neuralgia .....	70599
Brachial Neuritis .....	7051109
Caries, Cervical .....	502444
Cervical Rib .....	6092542
Cervico-brachial Neuralgia .....	70599
Fibrositis .....	105
Neurasthenia, Traumatic .....	10924739
Neuroma .....	5011109

Pachymeningitis, Cervical .....	40279144
Paralysis Agitans .....	504252
Progressive Muscular Atrophy.....	906599
Rheumatism .....	704
Syringomyelia .....	40297
Tumor, Spinal .....	508297
Valvular Disease .....	501256

#### Hand

Chondroma .....	50175
Gout .....	502119
Neuritis .....	907651
Neuroma .....	5011109
Raynaud's Disease .....	20777101
Rheumatism .....	704
Rheumatoid Arthritis .....	9027
Teno-synovitis .....	40645
Trauma .....	109226
Tubercle .....	40226

#### Thigh

Abdominal Tumor .....	5081233
Aneurysm, Abdominal .....	4014971233
Aneurysm, Femoral or Popliteal.....	401497114
Cancer of Rectum.....	50851
Caries, Lumbo-Sacral .....	5024193854
Colon, Growth on.....	50827
Dysmenorrhoea .....	70101
Fibrositis .....	105
Hip Disease .....	4021775
Hysteria .....	70936
Impacted Faeces .....	608427
Infantile Scurvy .....	108749
Locomotor Ataxy .....	50592
Lumbar Abscess .....	302193
Meningitis, Spinal .....	40279
Metritis .....	907651
Neurasthenia .....	40739
Neuritis .....	907651
Neuroma .....	5011109
Ovarian Cyst .....	601338 (or 334)
Pelvic Cellulitis .....	40954101
Pelvic Tumors .....	508525
Perimetritis .....	40954
Periostitis, Femoral .....	40359114
Pregnancy .....	60239
Psoas Abscess .....	302987
Renal Calculus .....	2094
Sacral Glands, Enlarged.....	401327854
Sarcoma of Femur.....	50884114
Sarcoma of Innominate.....	50884497 (or 4971)
Sciatica .....	40351935
Uterine Displacement .....	4035954
Vesical Calculus .....	209462

#### Howship-Romberg Sign

Obturator Hernia .....	104843
------------------------	--------

**Leg**

Infantile Paralysis .....	20692
Lead-poisoning .....	9011609
Leukaemia .....	401465
Osteomyelitis .....	40843453
Periostitis .....	40359
Phlebitis .....	40494
Rheumatism .....	704
Sciatica .....	40351935
Spinal Meningitis .....	40279
Tuberculous Bone .....	40284

**Foot**

Corns .....	508442
Gout .....	502119
Locomotor Ataxy .....	50592
Movable Kidney .....	20389
Neurasthenia .....	40739
Ovarian Disease .....	40338 (or 334)
Periostitis .....	40359
Prostatic Disease .....	40999
Raynaud's Disease .....	20777442 422
Renal Calculus .....	2094
Rheumatism .....	704
Trauma .....	1092442 422
Tuberculous Bone .....	40284

**Heel**

Arthritis, Gonorrhoeal .....	9027
Gout .....	502119
Lithaemia .....	407
Neurasthenia .....	40739

**Heel-Jar**

Spinal Caries .....	5024297
---------------------	---------

**Muscles (Myalgia)**

Alcoholism .....	9014004
Anaemia .....	20976
Biliary Congestion .....	20448
Cerebro-spinal Meningitis .....	4027929 (or 291)
Cholera .....	90118822
Coryza .....	904681
Duodenal Catarrh .....	60221602-22
Enteric Fever .....	70922
Fibrositis .....	10522
Influenza .....	30822
Visceral Inflammations .....	401233
Locomotor Ataxy .....	50592
Muscular Rheumatism .....	704
Psittacosis .....	80843
Rheumatic Fever .....	604
Scurvy .....	108749
Septicaemia .....	60327
Sprain .....	70599
Syphilis .....	505



Trichinosis .....	90837
Tuberculous Meningitis .....	402279
Weil's Disease .....	40118848

**Limbs, Pain in (Unclassified)**

Abdominal Tumors .....	5081233
Adhesions, Peritoneal .....	1011653
Appendicitis .....	6072
Caisson Disease .....	109277 (or 76)
Cancer of Rectum.....	50851
Cancer of Bone .....	5084
Cauda Equina, Tumor of.....	50821
Compression of Cord.....	90192297
Diabetes .....	5094
Erythromelalgia .....	808642163
Exostosis .....	3084
Fevers .....	709
General Paralysis .....	5042
Glanders .....	6049
Haemophilia .....	4096
Hysteria .....	70936
Influenza .....	308
Kidney, Floating .....	20387
Lead-poisoning .....	9011609
Locomotor Ataxy .....	50592
Mollities Ossium .....	6013453
Muscle, Rupture of.....	1048599
Myalgia .....	40599
Myelitis .....	403453
Myelosarcoma .....	503453
Myositis .....	40599
Neurasthenia .....	40739
Oophoritis .....	40338 (or 334)
Osteitis .....	4084
Paralysis Agitans.....	504252
Periarteritis Nodosa .....	4049758
Periostitis .....	40359
Phthisis, Advanced.....	40277 (or 76)
Progressive Muscular Atrophy.....	906599
Rheumatism .....	704
Softening, Chronic.....	6013453
Spinal Apoplexy.....	903297
Spinal Meningitis.....	40279
Strains .....	6093865
Syphilis .....	505
Tetanus .....	30785
Thrombosis .....	9098
Tonsillitis, Follicular.....	40476
Trichinosis .....	90837
Tuberculous Bone.....	40284
Urticaria .....	901547
Uterus, Cancer of.....	50954

## Joints

Arthritis, Gonorrhoeal.....	9027
Arthritis, Pneumococcal.....	9027217
Arthritis, Post-febrile.....	90279
Arthritis, Rheumatoid.....	902
Caisson Disease.....	109277 (or 76)
Cartilage, Displaced.....	4035154
Chorea.....	10393
Compression of Cord.....	90192297
Fibrositis.....	105
Glanders.....	6049
Gout.....	502119
"Growth Fever".....	507910
Gums, Septic.....	60591
Hip Disease.....	4021775
Infantile Paralysis.....	20692
Injuries.....	1092
Lead-Poisoning.....	9011609
Locomotor Ataxy.....	50592
Loose Cartilage.....	4035154
Myelitis, Acute.....	403453
Myelosarcoma.....	5083453
Neuralgia.....	80864
Phthisis, Advanced.....	40277 (or 76)
Pyæmia.....	60327
Recklinghausen's Disease.....	50110997
Rheumatism, Acute.....	704
Rheumatism, Chronic.....	902
Scurvy.....	108749
Synovitis.....	402008
Syphilis.....	505
Syringomyelia.....	40297
Tuberculous Joint.....	402119

## CHARACTER OF PAIN

### Sharp

Acute Inflammation of Serous Membranes.....	40766
Acute Inflammation of Synovial Membranes.....	402008
Angina Pectoris.....	7025
Appendicitis.....	6072
Ectopic Gestation.....	60239973 (or 2)
Fractures.....	907
Gout.....	502119
Neuritis.....	907651
Pleurisy, Acute.....	407 (or 71)
Pneumothorax.....	1092675
Spinal Meningeal Haemorrhage.....	10427279

### Dull

Chronic Inflammation of Serous Membranes.....	40766
Inflammation of Mucous Membranes.....	409766
Inflammation of Visceral Parenchyma.....	4023

### Paroxysmal

Aneurysm.....	401497
Angina, Abdominal.....	7021233 - ?

Angina, Oesophageal.....	70235
Angina Pectoris.....	7025
Appendicitis .....	6072
Appendicular Colic.....	6078
Calculus of Pancreas.....	204997
Cancer of Pancreas.....	50997
Cancer of Oesophagus.....	5035
Cerebral Tumors.....	501 (or 508) 29 (or 291)
Clot in Ureter.....	80799668 (or 6681)
Colitis .....	6021
Colic .....	7027
Diabetes .....	5092
Disseminated Sclerosis .....	90192
Distended Bladder.....	306562
Dysentery .....	6093
Dysmenorrhoea .....	70101
Erythromelalgia .....	808642163
Floating Kidney.....	20387
Gallstone Colic.....	702438
Heart, Syphilitic.....	50525
Henoch's Purpura.....	10427101
Hepatic Aneurysm.....	40149748
Hernia .....	1048
Hydatids of Kidney.....	3029137 (or 371)
Intussusception .....	207222
Lead Colic.....	70911609
Locomotor Ataxy .....	50592
Mercurialism .....	9017046
Neuralgia .....	80864
Ovarian Cyst.....	601338 (or 334)
Pulpitis, Dental.....	4051499
Pyloric Ulcer.....	30321
Renal Calculus.....	2094
Scybala or Concretions.....	8026127
Spinal Meningitis.....	40279
Tic-douloureux .....	808642285
Tubal Colic.....	502973 (or 2)
Tuberculous Synovitis.....	402008
Ureteral Calculus.....	2094668 (or 6681)
Urethral Calculus.....	2094439
Vesical Calculus.....	209462
Uterine Cancer .....	50954
Uterine Fibroids.....	501954
Uterine Polypus.....	30795197

→ 4028  
2008

### Radiating

Abdominal Aneurysm .....	4014971233
Acute Aortitis .....	40789
Aneurysm of Asc. Aorta.....	40149775
Aneurysm of Innominate.....	40149744
Angina, Abdominal .....	7021233
Angina Pectoris.....	7025
Aortic Regurgitation .....	402256
Atony of Stomach .....	107832

Caries of Spine.....	5024297
Cerebellar Tumors.....	501 (or 508) 231
Cervical Rib.....	6092542
Compression of Cord.....	90192297
Gastritis, Acute Erythematous.....	40732
Hepatic Colic.....	6078948
Hip Disease.....	4021775
Liver Affections.....	4048
Neuralgia.....	80864
Oophoritis.....	40338 (or 334)
Otitis Media, Acute.....	6013372
Pachymeningitis, External Spinal.....	40279
Pancreatic Calculus.....	204997
Pelvic Abscess.....	30295
Pulmonary Abscess.....	3027476 (or 77)
Rectum, Cancer of.....	50851
Renal Calculus.....	2094
Spinal Tumor.....	508297
Spinal Meningeal Haemorrhage.....	10427279
Spinal Meningitis, Internal.....	40279
Spleen Affections.....	40465
Uterine Fibroids.....	501954
Vesical Calculus.....	209462

#### **Shifting Pain**

Flatulence.....	6078927
Gout.....	502119
Hysteria.....	70936
Locomotor Ataxy.....	50592
Neuralgia.....	80864
Rheumatism.....	704
Spinal Tumor.....	508297
Tapeworm.....	907980
Trichinosis.....	90837

#### **Gnawing or Boring Pain**

Abdominal Aneurysm.....	4014971233
Cancer of Stomach.....	50321
Caries of Spine.....	5024297
Descending Thoracic Aneurysm.....	40149775
Gout.....	502119
Lithaemia.....	407
Mediastinal Growth.....	501 (or 508) 356
Periostitis.....	401653
Spinal Meningitis.....	40279

#### **Increased by Food**

Arsenic-poisoning.....	901656
Cancer of Stomach.....	5032
Cancer of Duodenum.....	50221
Cancer of Oesophagus.....	5035
Gastritis.....	40321
Renal Calculus.....	2094
Ulcer of Duodenum.....	30221
Ulcer of Stomach.....	30321

**Relieved by Food**

Appendicitis .....	6072
Cholecystitis, Chronic.....	20438
Gastralgia .....	40222
Hyperchlorhydria .....	8032110
Ulcer, Duodenal.....	30221

**Relieved by Pressure**

Colic, Abdominal.....	701233
Lumbago .....	40599193
Pleurodynia .....	70599542
Pleurisy .....	407 (or 71)
Muscle, Ruptured.....	1048599
Rib, Fractured.....	907542

**Increased by Movement**

Abscess, Local.....	302599
Abscess, Pelvic.....	302525
Appendicitis Larvata .....	607898
Arthritis .....	9027
Caries of Spine.....	5024297
Cartilage, Displaced.....	4035154
Faecal Accumulation .....	7029
Fibrositis .....	105
Fractures .....	907
Glandular Fever.....	709327
Gout .....	502119
Hernia, Obturator.....	104843
Lumbago .....	40599193
Myositis .....	40599
Neuritis .....	907651
Oophoritis .....	40338 (or 334)
Pachymeningitis, External Spinal.....	40279
Pelvic Cellulitis.....	40954101
Perinephritis .....	40379 (or 3719)
Peritonitis .....	401653
Pleurisy, Acute.....	407 (or 71)
Pleurodynia .....	70599542
Pneumonia, Acute.....	2017
Renal Calculus.....	2094
Rheumatism, Acute.....	702
Rheumatism, Muscular.....	704
Rheumatoid Arthritis.....	902
Ruptured Muscle.....	1048599
Salpingitis .....	502973 (or 2)
Sciatica .....	40351935
Spinal Column, Sprain of.....	70599279
Spinal Meningitis.....	40279
Spondylitis, Traumatic .....	1092297
Sprains .....	70599
Synovitis .....	402008
Tuberculous Joint.....	402119
Tumor, Cranial.....	501 (or 508) 84107
Tumor, Intracranial.....	501 (or 508) 29 (or 291)
Tumor, Spinal.....	501 (or 508) 297

Vesical Calculus.....	209462
Weil's Disease.....	40118848

**Increased by Breathing or Coughing**

Caries of Sternum or Spine.....	5024263 (or 297)
Cholecystitis .....	20438
Diaphragmatic Hernia.....	10488044
Diaphragmatic Pleurisy .....	4078044
Fractured Ribs.....	907542
Intercostal Rheumatism.....	704542
Perforation of Stomach.....	40632
Perihepatitis .....	4056648
Perinephritis .....	40379 (or 3719)
Peritonitis .....	401653
Pleurisy .....	407 (or 71)
Pneumothorax .....	1092675
Subphrenic Abscess.....	505991096
Trichinosis .....	90837

**Increased at Night**

Arthritis, Gonorrhoeal.....	9027
Carcinoma .....	50
Erythromelalgia .....	808642163
Locomotor Ataxy .....	50592
Neuritis .....	907651
Otitis Media .....	6013372
Osteitis .....	4084
Periostitis .....	40359
Renal Calculus.....	2094
Rheumatism .....	704
Syphilis .....	505
Tuberculous Joint .....	402119
Ulcer of Stomach.....	30321

**Referred Pain**

Angina Pectoris .....	7025
Dysmenorrhoea .....	70101
Heart Disease.....	4025
Liver Affections.....	4048
Ovarian Disease.....	40338 (or 334)
Renal Colic.....	209437 (or 371)

**TENDERNESS**

**Scalp**

Cerebral Tumor .....	501 (or 508) 29 (or 291)
Erysipelas .....	70798
Gumma .....	505101
Herpes .....	6024
Hydrocephalus .....	10821
Lupus Erythematosus .....	40249
Mastoid Abscess .....	602843
Meningitis .....	40279
Migraine .....	70964
Neuralgia, Cervico-occipital .....	90274
Neurasthenia .....	40739

Otitis Media .....	6013372
Recklinghausen's Disease .....	50110997
Rheumatism .....	704
Sclerodermia .....	501101
Seborrhoea, Acute .....	4011017
Syphilis, Congenital .....	507
Syphilitic Periostitis .....	505359
Thrombosis of Lateral Sinus.....	90989759
Trauma .....	1092
Trigeminal Neuralgia .....	808642285

### Spine

Abscess, Lumbar .....	302987
Abscess, Mediastinal .....	302356
Abscess, Perinephric.....	30223379 (or 3719)
Abscess, Post Pharyngeal .....	302198
Abscess, Subphrenic .....	505991096
Aneurysm, Abdominal .....	4014971233
Arthritis, Rheumatoid .....	902
Cancer of Spine.....	50297
Caries of Spine.....	5024297
Caries Sicca .....	5024
- Compression of Cord.....	90192297
Gastritis .....	4032
Glands, Enlarged Bronchial.....	8054
Heart Disease .....	4025
Hepatic Colic .....	6078948
Hysteria .....	70936
Liver Disease .....	4048
Mediastinal Tumor .....	501 (or 508) 356
Meningitis, Cerebro-spinal .....	4029279
Meningitis, Spinal .....	40279
Myelitis, Chronic .....	403453
Neurasthenia .....	40739
- Neurasthenia, Traumatic .....	10924739
Spinal Apoplexy .....	903297
Spinal Periostitis .....	4084297359
Spondylitis, Traumatic .....	1092297
Spondylose Rhizomelique .....	402867
Tumors of Spine.....	508297
Typhoid Spine .....	203143279
Ulcer of Duodenum.....	30221
Ulcer of Stomach.....	30321

### Lumbar Tenderness

Appendicitis .....	6072
Lumbar Abscess .....	302987
Nephritis, Acute .....	4037 (or 371)
Nephritis, Suppurative .....	6037 (or 371)
Perinephric Abscess .....	30223379 (or 3719)
Perinephritis .....	40379 (or 3719)
Renal Calculus .....	2094
Renal Cancer .....	5037 (or 371)
Renal Infarct .....	4042737 (or 371)

## Chest

Abscess, Hepatic .....	304248
Aneurysmal Prominence .....	40149775
Angina Pectoris .....	7025
Bronchitis, Acute .....	402392
Caries of Sternum.....	5024263
Diaphragmatic Neuralgia .....	808648044
Empyema Necessitatis .....	6075327
Heart Strain .....	609386525
Herpes Zoster .....	60240101542
Hysteria .....	70936
Intercostal Neuralgia .....	702542
Intercostal Rheumatism .....	704542
Mediastinal Disease .....	40356
Myocarditis .....	405992572
Pericarditis .....	402587
Periostitis, Costal .....	40359542
Periostitis, Sternal .....	40359263
Phthisis .....	40277 (or 76)
Pleurisy, Acute .....	407 (or 71)
Pleurisy, Diaphragmatic .....	4078044

## Mamma or Breast

Abscess .....	30274 (or 73)
Hysteria .....	70936
Mastitis .....	4074 (or 73)
Menstruation .....	8014
Oophoritis .....	40338 (or 334)
Pregnancy .....	60239

## Right Hypochondrium

Abscess of Liver.....	304248 (or 487)
Actinomycosis .....	6049
Acute Yellow Atrophy.....	2044048 (or 487)
Asthma .....	70949
Cancer of Liver.....	5048 (or 487)
Cirrhosis of Liver, Hypertrophic.....	109148
Cyanotic Liver .....	1010148748
Empyema of Gall-bladder.....	6038
Fatty Degeneration of Liver.....	908948
Gallstones .....	20438
Hepatitis, Acute .....	4048
Hydatids, Inflamed .....	30291
Influenza .....	308
Jaundice, Obstructive .....	40811
Malaria .....	302
Myocarditis .....	405992572
Perihepatitis .....	4056648
Sarcoma of Liver.....	50848
Syphilitic Liver .....	50548
Weil's Disease .....	40118848

## Left Hypochondrium

Anaemia, Splenic .....	20976465
Enteric Fever .....	709222



Impacted Faeces .....	608427
Influenza .....	308
Leukaemia, Spleno-medullary .....	508465
Malaria .....	302
Perisplenitis .....	40599465
Spleen, Abscess of.....	302465
Spleen, Cancer of.....	50465
Spleen, Infarct of.....	10427465

## ABDOMINAL TENDERNESS

### Epigastrium

Acute Yellow Atrophy.....	2044048 (or 487)
Addison's Disease .....	50112
Appendicitis Larvata .....	607898
Arsenic-poisoning .....	901656
Cancer of Stomach.....	5032
Cirrhosis of Stomach.....	109132
Dilated Right Ventricle.....	3065259
Gallstones .....	20438
Gastritis, Acute Erythematous.....	40732
Gastritis, Chronic .....	4032
Hypochondriasis .....	10976
Hysteria .....	70936
Irritant-poisoning .....	90148
Liver Tenderness .....	4048
Pancreas, Inflammation of.....	40997
Pericarditis, Acute .....	402587
Peritonitis .....	401653
Pleurisy, Diaphragmatic .....	4078044
Ulcer of Stomach.....	30321

### Iliac

Abscess of Abdominal Wall.....	301233599
Alcoholism .....	9014004
Appendicitis .....	6072
Caecum Mobile .....	808782
Calculus, Renal .....	2094
Calculus, Ureteral.....	2094668 (or 6681)
Cancer of Caecum.....	5082
Cancer of Uterus.....	50954
Cervix, Eroded .....	502952
Dysmenorrhoea .....	70101
Enteric Fever .....	709222
Faecal Accumulation .....	7029
Hysteria .....	70936
Neuralgia of 12th Dorsal N.....	80864212
Oophoritis .....	40338 (or 334)
Pelvic Cellulitis .....	40954101
Pelvic Peritonitis .....	401653252
Pneumoperitonaeum .....	20171653
Prolapsus Uteri .....	8087954
Psoas Abscess .....	302987
Retroflexion .....	90542
Sacro-iliac Disease .....	402854374

Salpingitis .....	502973 (or 2)
Sigmoiditis .....	4085
Tubal Gestation .....	60239973 (or 2)
Tubercle of Caecum.....	40282
Uterine Congestion .....	40149954
<b>Erichsen's Sign</b>	
Sacro-iliac Disease .....	402854374
<b>Hypogastrium</b>	
Bladder, Ulcer of.....	3062
Calculus, Vesical .....	209462
Cystitis .....	6062
Dysmennorrhoea .....	70101
Metritis, Acute .....	907651
Pelvic Peritonitis .....	401653252
Pericystitis .....	4062
Perimetritis .....	40954
<b>Perinaeum, Tender</b>	
Abscess, Ischio-rectal .....	50851835
Abscess, Prostatic .....	302999
Abscess, Urethral .....	302439
Haemorrhoids, Inflamed .....	4025T (or 296)
Proctitis .....	12 40851

## THE EARS

<b>Malformations</b> .....	10937
Absent Auricles .....	109379 (or 91)
Fistulous Auricles .....	7069 (or 91)
Frostbite .....	1059 (or 91)
<b>Tophi</b>	
Gout in System.....	502119
<b>Haematoma (Blood Tumor)</b> .....	4092
Dementia .....	5073
Epilepsy .....	2092
General Paralysis .....	5042
Mania .....	6049
Melancholia .....	10976
Trauma .....	1092
<b>Waxy Ears</b> .....	406
Addison's Disease .....	50112
Anaemia .....	20976
Chlorosis .....	4095
Frostbite .....	1059 (or 91)
Leukaemia .....	401465
<b>Livid Ear</b>	
Cold .....	904681
Dyspnoea .....	20494734
Malformation of Heart.....	1093725
<b>Swollen Ear</b> .....	4019 (or 91)
Abscess .....	3042
Blows .....	10919 (or 91)

Erysipelas .....	70798
Furunculosis .....	409213372
Gummata .....	5051019 (or 91)
Herpes .....	6024013372
Inflamed Tophi .....	40209 (or 91)
Mastoiditis .....	602843
Oedema .....	30785(9)(91)
<b>Gangrenous Ear</b> .....	207779 (or 91)
Frostbite .....	1059 (or 91)
Raynaud's Disease .....	207779 (or 91)
Trauma .....	10929 (or 91)
<b>Growths on Ear</b> .....	501 (or 508) 9 (or 91)
Aneurysm, Cirroid .....	401497
Angioma .....	4097199 (or 91)
Chondroma .....	501759 (or 91)
Dermoid Cysts .....	601789 (or 91)
Epithelioma .....	4059 (or 91)
Rodent Ulcer .....	50842309 (or 91)
Sarcoma .....	5089 (or 91)
Sebaceous Cyst .....	6019 (or 91)
<b>Bleeding from Meatus</b> .....	1042713372
Erosion .....	50213372
Fracture of Base of Skull .....	907844147
Otitis, Acute Haemorrhagic .....	4014279 (or 91)
Polypus .....	307519 (or 91)
Trauma .....	10929 (or 91)
<b>Swelling in Meatus</b> .....	4013372
Diphtheria .....	20932
Exostosis .....	308413372
Furuncle .....	409213372
Granulations .....	50213372
Mastoiditis .....	602843
Otomycosis .....	604913372
Parotid Abscess .....	3022795
Perichondritis .....	40154
Polypus .....	307519 (or 91)
<b>Otorrhoea (Discharge from Meatus)</b> .....	6013372
Abscess Bursting into Ear .....	302449 (or 91)
Carcinoma .....	509 (or 91)
Caries or Necrosis of Temporal Bone .....	20897
Diphtheria of Meatus .....	2093213372
Eczema of Meatus .....	305313372
Epithelioma .....	40513372
Foreign Body in Meatus .....	1047413372
Fracture of Base of Skull .....	907844147
Furuncle in Meatus .....	409213372
Granulations .....	50213372
Otitis Media, Suppurative .....	60413372
Otitis Media, Tuberculous .....	402413372
Pachymeningitis .....	402791
Polypus .....	30751

Sebaceous Cyst, Suppurating.....	601691
Thrombosis of Lateral Sinus.....	90989759
<b>Membrane Perforated or Ruptured</b> .....	10915669 (or 91)
Middle Ear Suppuration.....	6013372
Trauma .....	109213372
Tuberculosis .....	40213372

## THE HEARING

<b>Deafness</b> .....	2010
Adenoids .....	90138
Atrophy of Brain.....	9061332
Auditory Neuritis .....	70511808
Boil in Meatus.....	409213372
Congenital Defect .....	1093713372
Coryza .....	904681
Diphtheria .....	20932
Enteric Fever .....	709222
Eustachian Obstruction .....	2073226
Facial Paralysis .....	50422285
Haemorrhage, Intracranial .....	10427279107
Hay Fever .....	6096
Hydrocephalus .....	60184107
Hysteria .....	70936
Labyrinth, Tumor of.....	501 (or 508) 2855
Labyrinth, Cancer of.....	502855
Lead-poisoning .....	9011609
Lesion of Medulla.....	50844
Lesion of Pons.....	50829744
Lesion of Cerebellum.....	508231
Lesion of Corpora Quadrigemina.....	5081332
Leukaemia .....	401465
Locomotor Ataxy .....	50592
Measles .....	10322
Meniere's Disease .....	402855
Meningitis .....	40279
Meningitis, Cerebro-spinal .....	4029279
Mumps .....	10327
Nephritis, Chronic .....	4037 (or 371)
Otitis Interna .....	40122
Otitis Media .....	6013372
Pernicious Anaemia .....	50465
Pharyngitis .....	40198
Polypi, Aural .....	307519 (or 91)
Polypi, Nasal .....	3075196
Rheumatoid Arthritis .....	902
Ruptured Tympanum .....	10924433
Shock .....	10104
Syphilis .....	505
Typhus .....	709222
Uraemia .....	50637371
Wax in Meatus.....	40613372

**Paracusis Willisii**

Middle Ear Catarrh.....	60213372
Otosclerosis .....	90313372

**Autophonia**

Middle Ear Catarrh.....	60213372
-------------------------	----------

**Tinnitus Aurium (Ringing in Ears.)**

Alcoholism, Chronic.....	9014004
Anaemia of Brain.....	4081
Aneurysm, Cerebral .....	4084929 (or 291)
Apoplexy .....	104271332
Arterio-sclerosis .....	903
Aura Epileptica .....	2092
Blow upon Head.....	1092107
→ Catalepsy .....	90798
Cervico-occipital Neuralgia .....	90274
Cholera .....	90118822
Delirium Tremens .....	4040049
Enteric Fever .....	709222
Exophthalmos, Pulsating .....	3066549
Foreign Body .....	10474
— Fracture of Base.....	9078444
Gout .....	502119
Herpes Auris .....	6024013372
Hypertrophy of Heart.....	40125
Hysteria .....	70936
Indigestion .....	40322227
Labyrinthine Disease .....	4020855
Leukaemia .....	401465
Lithaemia .....	407
Malaria .....	302
Mania .....	60495
Mastoid Disease .....	602843
Meniere's Disease .....	402855
Meningitis .....	40279
Middle Ear Catarrh.....	60213372
Migraine .....	70964
Mumps .....	10327
Nephritis, Chronic .....	4037 (or 371)
Neurasthenia .....	40739
Obstructed Eustachian Tube.....	2073226
Otitis, Suppurative .....	6013372
Otosclerosis .....	90313372
Polypus, Aural .....	307519 (or 91)
Polypus, Nasal .....	3075196
Syphilis, Labyrinthine .....	5052855
Tapeworm .....	907980
Thrombosis, Cerebral .....	909829
Tumor of Brain.....	5011332
Typhus .....	709222
Wax in Meatus.....	40613372

**Fistel-Symptom**

Labyrinthine Fistula .....	7062855
----------------------------	---------

# THE EYES

## THE EYELIDS

### Ecchymosed

Endocarditis, Infective .....	5023795
Fracture of Base .....	9078444
Haemophilia .....	4096
Infantile Scurvy .....	105749
Injuries .....	1092
Measles, Malignant .....	10322
Purpura Haemorrhagica .....	1042910196
Scurvy .....	108749
Straining .....	60938653 (or 31)
Thrombosis, Cerebral .....	909829 (or 291)
Typhus, Malignant .....	709222
Variola, Malignant .....	403101
Vomiting .....	90705
Whooping-cough .....	9079

### Swollen Lid

Anaemia .....	20976
Anasarca .....	60102
Angioneurotic Oedema .....	40973785
Arsenic poisoning .....	901656
Cyst of Lid .....	601979
Dacryocystitis .....	409533 (or 31)
Erysipelas .....	70798
Frontal Sinus Distension .....	3065133
Glanders .....	6049827
Glaucoma .....	40269
Hay Fever .....	6096
Injuries .....	1092
Iodism .....	901884
Measles, German .....	10374
Mediastinitis .....	40356
Stye .....	409204
Tenonitis .....	403512
Thrombosis of Cavernous Sinus .....	90989759
Thrombosis of Long. Sinus .....	9098975
Trachoma .....	50740
Trichinosis .....	90837
Urticaria .....	901547
Variola .....	403101
Whooping Cough .....	9079

### Darkened Lids

Amenorrhoea .....	801954
Anaemia .....	20976
Chlorosis .....	4095
Digestive Troubles .....	403222
Exophthalmic Goitre .....	30665
Fatigue .....	8069
Hepatic Colic .....	6078948
Leukorrhoea .....	3071336 (or 332)

Menorrhagia .....	6098954
Menstruation .....	8018 <sup>?8014?</sup>
Phthisis .....	40277 (or 76)
<b>Localized Swellings</b> <sup>(mumps)</sup> <i>Dacryoadenitis</i> <del>6327</del> <sup>(953)<sup>3</sup></sup> <sub>31</sub>	
Chalazion .....	6015107
- Dacryocystitis .....	409533 (or 31)
Epithelioma .....	405
- Stye .....	409204
Tophi, Gouty .....	502499
- Trachoma .....	50740
Warts .....	10972
Xanthelasma .....	9089979
<b>Nictitation (Blinking)</b>	
Catalepsy .....	90798
Chorea .....	10393
Epilepsy .....	2092
Exophthalmic Goitre .....	30665
Hysteria .....	70936
Neurasthenia .....	40739
Paralysis Agitans .....	504252
Temporal Caries .....	502484862
Trigeminal Neuralgia .....	808642285
Tumors .....	501 (or 508) 979
<b>Drooping (Ptosis)</b> .....	
Acute Ascending Paralysis.....	5042592163
Apoplexy .....	903
Bulbar Paralysis .....	504286544
Cerebro-spinal Meningitis .....	4027929 (or 291)
Concussion of Brain.....	90748
Diphtheritic Paralysis .....	20932542
Exophthalmic Goitre .....	30665
Facial Hemiatrophy .....	9016562285
Facial Paralysis .....	50422285
Gummata .....	50552976
Hysteria .....	70936
Locomotor Ataxy .....	50592
Myasthenia Gravis .....	90632281
Neurasthenia .....	40739
Ophthalmoplegia Externa .....	50425993 (or 31)
Orbital Disease .....	403 (or 31)
Paralysis Agitans .....	504252
Paralysis of Third Nerve.....	50422283
Paralysis of Sympathetic.....	50427393 (or 31)
Ptosis Congenita .....	8087
Syringomyelia .....	40297
Tetanus .....	30785
Trachoma, Old .....	5074
Trigeminal Neuralgia .....	808642285
Tuberculous Meningitis .....	402279
Tumor of Crus .....	501 (or 508) 42 (or 3)

**Lid Always Open (Lagophthalmos)**

Contraction of Scars	10142 (or 31)
Exophthalmic Goitre	30665
Facial Paralysis	50422285
Landouzy-Dejerine Paralysis	40118848
Leprosy	408
Tumor of Orbit	5013988

**Crusted Edges**

Eczema	3053
Intestinal Irritation	60422
Ophthalmia	40776
Stye	409204
Sycosis Tarsi	40979
Tinea Tarsi	30979

**Stellwag's Sign**

Action of Cocaine	90126
Exophthalmic Goitre	30665
Sympathetic Nerve Stimulation	409739

**Graefe's Symptom**

Action of Cocaine	90126
Exophthalmic Goitre	30665
Sympathetic Nerve Stimulation	409739

**Kocher's Symptom**

Exophthalmic Goitre	30665
---------------------	-------

**THE CORNEA****Hazy**

Glaucoma, Acute	40269
Keratitis	3023988
Ulceration	303988

**Arcus Senilis**

Arterio-sclerosis	903
Fatty Heart	908925
Senility	3048

**Keratitis, Symptomatic**

Diabetes	5094
Exophthalmic Goitre	30665
Meningitis	40279
Paralysis, Trigeminal	50422285
Syphilis, Congenital	5073988
Tuberculosis	4023988
Tumor of Orbit	5013988

**Ulcers**

Catarrhal	60236
Diphtherial Ulcer of Eye	209323 (or 31)
Gonorrhoeal	5023
Herpetic	60243988
Phlyctenular	303998
Rodent Ulcer, Mooren's	50301013998
Simple	303998



Trachomatous .....	507403998
Tuberculous .....	402303998

**Corneal Reflex Abolished**

Coma .....	50637371
Diabetes .....	5094
Exophthalmic Goitre .....	30665
Hemiplegia .....	4096
Herpes Frontalis .....	401109596
Hysteria .....	70936
Meningitis .....	40279
Paralysis, Trigeminal .....	50422285

**THE SCLEROTIC OR WHITE OF EYE**

**Pearly**

Addison's Disease .....	50712
Anaemia .....	20976
Chlorosis .....	4095
Nephritis .....	4037 (or 71)
Phythisis .....	40277 (or 76)

**Yellow**

Alcoholism .....	9014004
Jaundice .....	40811
Melancholia .....	10976
Subconjunctival Fat .....	90893776

**THE CONJUNCTIVA**

**Watery (Lacrymation)**

Alcoholism, Chronic .....	9014004
Asthma, Spasmodic .....	402392
Chlorosis .....	4095
Conjunctivitis, Parinaud's .....	403776
Coryza .....	904681
Foreign Body .....	10474
Hay Fever .....	6096
Influenza .....	308
Iodism .....	901884
Irritants .....	9011021
Landouzy-Dejerine Paralysis .....	40118848
Measles .....	10374
Neuralgia, Trigeminal .....	50422285
Typhus .....	709222
Whooping-cough .....	9079

**Pallid**

Anaemia .....	20976
---------------	-------

**Overflowing Tears (Epiphora)**

Abscess of Sac .....	3042953
Blepharitis, Marginal .....	403979
Dacryocystitis .....	409533
Displacement of Punctum .....	8087304
Exophthalmic Goitre .....	30665

Facial Paralysis .....	50422285
Lupus .....	402101
Sclerodermia .....	501101
Septum, Deviate .....	403515496
Tumors, Orbital .....	5013988

#### Fixed Eye Balls

Epilepsy .....	2092
Exophthalmic Goitre .....	30665
Locomotor Ataxy .....	50592
Thrombosis .....	90983512

#### Purulent Discharge

Abscess of Sac .....	3042953
Conjunctivitis .....	403776
Diphtheritic .....	209323776
Gonorrhoeal .....	5023776
Simple .....	603776
Tuberculous .....	4023776

#### Protruding (Exophthalmos or Proptosis)

Aneurism of Orbit.....	4014973 (or 31)
Apoplexy .....	903
Arthritis, Rheumatoid .....	902
Asthma, Spasmodic .....	402392
Carcinoma .....	503 (or 31)
Chloroma .....	50277784
Cocaine .....	206
Cysts of Orbit.....	6013 (or 31)
Distension of Frontal Sinus.....	3065133
Dyspnoea .....	307494734
Encephalocele .....	10481332
Encephaloid Cancer .....	501332
Epilepsy .....	2092
Ethmoid Cells, Dilated.....	3065993
Exophthalmic Goitre .....	30665
Exostosis of Orbit.....	30843 (or 31)
Fracture of Orbital Plate.....	907384
Glaucoma, Acute .....	40269
Gumma of Orbit.....	5053 (or 31)
Hydatids of Orbit.....	302913 (or 31)
Hydrocephalus .....	60184107
Hypertrophy of Heart.....	40125
Infantile Scurvy .....	108749
Intranasal Growth .....	90138
Lacrymal Gland, Enlarged.....	401351
Lymphadenoma .....	302758
Lymphatic Leukaemia .....	401465327
Meningocele .....	1048327
Myopia .....	9063647
Nephritis, Chronic .....	4037 (or 371)
Ophthalmoplegia .....	50425993 (or 31)
Orbit, Tuberculous .....	4023 (or 31)
Orbital Periostitis .....	403593 (or 31)
Paralysis of Third Nerve.....	50422283

Retrobulbar Haemorrhage .....	104273709
Scurvy .....	108749
Sphenoidal Sinusitis .....	602133
Tenonitis .....	403512
Thrombosis of Cavernous Sinus.....	90989759
Thrombosis of Sup. Long. Sinus.....	9098975
Thymus, Enlarged .....	401396
Tumor of Antrum.....	501254
Tumor of Optic Nerve.....	5012282
Tumor of Orbit.....	5013988
Varix of Orbit.....	4014943 (or 31)
Vomiting, Persistent .....	90705

## THE PUPILS

### Pupils Dilated (One)

Aneurysm of Aorta.....	4014977898
Aneurysm of Innominate.....	40149744
Cataract .....	807
General Paralysis .....	5042
Glaucoma .....	40269
Lens, Dislocation of.....	80873777
Paralysis of Third Nerve.....	50422283
Pleural Effusion .....	6017 (or 71)
Tuberculous Meningitis .....	402279
Tumor of Brain.....	501 (or 508) 1332
Tumor of Neck.....	501523

### Pupils Dilated (Both)

Acute Yellow Atrophy.....	2044048 (or 487)
Alcoholic Coma .....	901400456
Amaurosis .....	5075297
Anaemia .....	20976
Anaemia of Brain.....	40849
Aortic Regurgitation .....	402256
Apoplexy .....	903
Catalepsy .....	90798
Concussion of Brain.....	90748
Dementia, Acute Primary.....	2016
Diabetic Coma .....	509456
Diphtheritic Paralysis .....	20932542
Dyspnoea .....	207494734
Epilepsy .....	2092
Glaucoma .....	40269
Hydrocephalus .....	10821
Hysteria .....	70936
Melancholia .....	10976
Meningitis, Simplex .....	40279
Meningitis, Tuberculous .....	402279
Myelitis, Acute .....	403453
Myopia .....	9063647
Nausea .....	40932
Neurasthenia .....	40739
Pain, Acute .....	70

Ptomainism .....	90154722
Sunstroke .....	407279
Syncope .....	207497
Thrombosis, Cerebral .....	909829 (or 291)
Action of	
Alcohol .....	9014004
Belladonna .....	901488
Cocaine .....	90126
Pituitrin .....	6098
Tobacco .....	40476

**Pupils Contracted (One)**

Amaurosis of Spinal Origin.....	5075297
Aneurysm of Aorta.....	401497789
Cerebral Haemorrhage .....	903
Fracture of Base.....	9074107
General Paralysis .....	5024
Iritis .....	402534
Klumpke's Paralysis .....	906344
Lesion of Cord.....	508297
Locomotor Ataxy .....	50592
Migraine .....	70964
Paralysis of Sympathetic.....	50427393 ( or 31)
Syringomyelia .....	40297
Tumor of Neck.....	501523

**Pupils Contracted (Both)**

Anaemia of Brain.....	40849
Apoplexy .....	903
Caries, Cervical .....	502444
Cerebral Hyperaemia .....	40929 (or 291)
Compression of Brain.....	106821332
Concussion of Brain.....	90748
Haematoma of Dura Mater.....	80799279
Haemorrhage into Pons.....	1042727944
Haemorrhage into Cerebellum.....	10427231
Hypermetropia .....	5063709
Iritis .....	402534
Locomotor Ataxy .....	50592
Mania .....	60495
Meningitis .....	40279
Meningitis, Cerebro-spinal .....	4027929 (or 291)
Mitral Stenosis .....	2072567
Morphinism .....	9014056
Retinitis .....	403709
Sunstroke .....	407279
Tuberculous Meningitis .....	402279
Typhus .....	709222
Uraemia .....	50637 (or 371)

**THE VISION**

**Diplopia (Double Vision)**

Alcoholism .....	9014004
Diphtheritic Paralysis .....	20932542

Disseminated Sclerosis .....	90192
Locomotor Ataxy .....	50592
Myasthenia Gravis .....	90632281
Ophthalmoplegia Externa .....	50425993 (or 31)
Paralysis of:	
External Rectus .....	504259931
Internal Rectus .....	504259933
Inferior Rectus .....	504259934
Superior Rectus .....	504259932
Inferior Oblique .....	504259938
Superior Oblique .....	504259936
Tumor of Brain.....	501 (or 508) 1332

### Diplopia, Monocular

Astigmatism .....	20612
Cataract, Incipient .....	203988
Dislocation of Lens.....	80873777
Tumor of Brain.....	501 (or 508) 1332
Raynaud's Disease .....	20777101
Rheumatoid Arthritis .....	9027
Scotoma .....	90984943
Syringomyelia .....	40297

### Chromatopsia or Color-Blindness

Congenital Defect .....	109373 (or 31)
Hysteria .....	70936
Kidney, Cirrhosis of.....	109137 (or 371)
Neurasthenia .....	40739
Optic Atrophy .....	906808
Optic Neuritis .....	70155808

### Hemeralopia (Night-Blindness)

Ague .....	30248709
Nephritis .....	4037 (or 371)
Scurvy .....	108749

### Muscae Volitantes (Black Specks)

Anaemia of Brain.....	4081
Cholera .....	90118822
Cataract .....	8087
Duodenal Catarrh .....	60221
Haemorrhage .....	10427
Hyperaemia of Brain .....	4094976
Hypertrophy of Heart.....	40125
Hysteria .....	70936
Liver Disorders .....	4048 (or 487)
Tumor of Brain .....	501 (or 508) 1332

### Sparks or Flashes

Apoplexy .....	903
Aura epileptica .....	2092
Epilepsy .....	2092
Hyperaemia of Brain.....	4094976
Hypochondriasis .....	10976
Hysteria .....	70936
Insanity .....	60495

Meningitis .....	40279
Migraine .....	70964
Neurasthenia .....	40739
Thrombosis, Cerebral .....	909829 (or 91)
Tumor, Cerebral .....	501 (or 508) 29 (or 291)

### **Garel's Sign**

Empyema of Antrum.....	60254
------------------------	-------

### **Photophobia (Intolerance of Light)**

Anaemia of Brain.....	40849
Arsenic-poisoning .....	901656
Cerebro-spinal Meningitis.....	4027929 (or 291)
Conjunctivitis .....	403776
Encephalitis .....	401332
Gastritis, Acute .....	70321
Hyperaemia of Brain.....	4094976
Hysteria .....	70936
Iritis .....	402534
Keratitis .....	3023988
Measles .....	10322
Meningitis .....	40279
Migraine .....	70964
Neuralgia, Trigeminal .....	808642285
Neurasthenia .....	40739
Retinitis .....	403709
Trichinosis .....	90837
Typhus .....	709222
Ulcer of Cornea .....	303988
Whooping Cough .....	9079

### **Amblyopia**

Acromegaly .....	309694
Alcoholism .....	9014004
Atrophy of Brain.....	9061332
Diphtheritic Paralysis .....	20932542
Haemorrhage .....	10427
Hydrocephalus .....	60184107
Locomotor Ataxy .....	50592
Mercurialism .....	9017046
Migraine .....	70964
Neurasthenia .....	40739
Syringomyelia .....	40297
Tumor of Brain.....	501 (or 508) 1332

### **Crossed Amblyopia**

Haemorrhage, Cerebral .....	903
-----------------------------	-----

### **Macropia and**

#### **Micropia**

Epilepsy .....	2092
Fatigue of Retina .....	30673709

### **Amaurosis or Blindness from extra-ocular causes**

Alcoholism .....	9014004
Amenorrhoea .....	801954
Anaemia of Brain .....	4081

Cerebellar Disease .....	401332
Cerebral Haemorrhage .....	903
Cerebro-spinal Meningitis .....	4027929 (or 291)
Chloroma .....	50277784
Cirrhosis of Kidney.....	109137 (or 371)
Embolism of Brain.....	90749
Epilepsy .....	2092
Hydrocephalus .....	10821
Hysteria .....	70936
Lead-poisoning .....	9011609
Locomotor Ataxy .....	50592
Meningitis .....	40279
Migraine .....	70964
Softening of Brain.....	6011332
Suppression of Menses.....	801954
Syphilis .....	505
Tobacco, Abuse of.....	201779
Tumor of Brain.....	501 (or 508) 1332
Uraemia .....	50637 (or 371)

## THE NOSE

### Red

Acne Rosacea .....	9083
Alcoholism .....	9014004
Amenorrhoea .....	801954
Boil .....	4092
Dyspepsia .....	608
Erysipelas .....	70798

### Nose Swollen

Erysipelas .....	70798
Injury .....	10972

### Gangrenous Tip of Nose

Lupus .....	402101
Raynaud's Disease .....	20777101
Syphilis .....	50596

### Distension of Transverse Nasal Vein

Adenoids .....	90138
----------------	-------

### Sneezing

Adenoids .....	90138
Asthma .....	70949
Coryza .....	904681
Ear, Irritation in.....	409 (or 91)
Gout .....	502119
Hay Fever .....	6096
Hysteria .....	70936
Iodism .....	901884
Measles .....	10374
Polypus .....	3075196
Spur of Septum.....	50115496
Whooping Cough .....	9079

## THE NOSTRILS

### Obstructed Nostrils

Abscess of Septum .....	302415496
Adenoids .....	90138 <sup>v</sup>
Antrum, Distended .....	3065254 <sup>v</sup> 2
Coryza .....	904681
Cyst, Middle Turbinate.....	601154484
Diphtheria .....	20932
Eczema Crusts .....	305396
Exostosis .....	3084
Foreign Body .....	10474
<i>Actinimycosis</i> — Glanders .....	6049
Gummata .....	50596
Haematoma of Septum.....	409215496
Hay Fever .....	6096
Malignant Disease .....	5096
Pharynx, Growth in.....	501 (or 508) 19
Polypus .....	3075196
Post-pharyngeal Abscess .....	30219
Sinusitis .....	6036
Spur of Septum.....	50115496
Syphilis .....	50596
Tubercle .....	40296
Turbinate Bone, Enlarged.....	40115496
Typhus .....	709222
Variola .....	403101

## RHINORRHOEA

### Watery or Mucous

Arsenic-poisoning .....	901656
Bronchitis .....	6024
Coryza .....	904681
Foreign Body .....	10474
Fracture of Base.....	907844
Hay Fever .....	6096
Influenza .....	30896
Iodism .....	901884
Measles .....	10374
Spasmodic Asthma .....	402392
Trigeminal Neuralgia .....	808642285
Typhus .....	709222
Whooping Cough .....	9079
Worms .....	9080

### Purulent Discharge or Ozaena

Cancer .....	50
Caries of Ethmoid.....	5042993
Diphtheria, Nasal .....	2093296
Empyema of Antrum.....	60254
Empyema of Frontal Sinus.....	60133
Foreign Body .....	10474
Glanders .....	6049
Gonorrhoea .....	502



Lupus .....	402101
Necrosis .....	3023
Sarcoma .....	508
Scarlatina .....	10743
Syphilis, Hereditary .....	507
Syphilis, Tertiary .....	50559
Tuberculous Rhinitis .....	40296
Ulceration .....	3096

**Epistaxis or Bleeding**

Adenoids .....	90138
Ague .....	30248709
Alcoholism .....	9014004
Amenorrhoea .....	801954
Anaemia .....	20976
Angioma .....	40971996
Aortic Insufficiency .....	109101
Arsenicism .....	901884
Arterio-sclerosis .....	9038
Bronchial Glands, Enlarged.....	8054
Bronchitis .....	6024
Carcinoma of Nose.....	5096
Caries, Nasal .....	502496
Catarrh, Chronic Nasal.....	60296
Chloroma .....	50277784
Chlorosis .....	4095
Cirrhosis of Kidney.....	109137 (or 371)
Cirrhosis of Liver.....	109148 (or 487)
Diphtheria .....	20932
Dysentery .....	6093
Emphysema of Lung.....	60277 (or 76)
Enteric Fever .....	709222
Erysipelas .....	70798
Fibroma of Nose.....	50196
Foreign Body .....	1047496
Fracture of Base.....	9078444
Goitre .....	30665
Haemophilia .....	4096
Hyperaemia of Brain.....	40940976
Hypertrophy of Heart.....	40125
Infantile Scurvy .....	108749
Influenza .....	308
Jaundice .....	40811
Leukaemia .....	401465
Measles .....	10374
Menopause .....	10
Mitral Stenosis .....	2072567
Nephritis, Chronic .....	4037 (or 371)
Ovarian Disease .....	40338 (or 334)
Peritonitis .....	401653
Pernicious Anaemia .....	50465
Phosphorus-poisoning .....	901695
Pleurisy .....	407 (or 71)
Polypus .....	30751
Psittacosis .....	80843

Purpura Haemorrhagica .....	1042910196 -
Sarcoma of Nose.....	50896
Scarlatina .....	10743
Scurvy .....	108749
Telangiectasis .....	409719
Thymus, Enlarged .....	401396
Tuberculosis .....	40296
Tumors of Neck.....	501523
Ulcer of Nose.....	3096
Varicosities .....	203496
Whooping-cough .....	9079
Worms .....	9080
Yellow Atrophy, Acute.....	2044048 (or 487)

## SENSATION

### PARASTHESIAE

<b>Numbness</b> .....	7074
Aneurysm .....	401497
Appendicitis .....	6072
Apoplexy .....	903
Apoplexy, Spinal .....	903279
Arteritis .....	40497
Aura Epileptica .....	2092
Cervical Rib .....	7074694542
Circulation, Defective .....	3065494 (or 497)
Disseminated Sclerosis .....	90192
Emboli .....	4079
Hyperaemia, Spinal .....	409297
Hysteria .....	70936
Hysterical Oedemá .....	709363785
Leprosy .....	408
Locomotor Ataxy .....	50592
Myelitis, Acute .....	403453
Neuralgia .....	80864
Neurasthenia .....	40739
Neuritis .....	907651
Neuroma .....	5011109
Pressure upon a Nerve-trunk.....	5011109279
Recklinghausen's Disease .....	50110997
Sciatica .....	40351935
Spinal Tumor .....	508297
Softening, Chronic Spine.....	601297
Syringomyelia .....	40297
Tetany .....	30785
Thrombosis .....	9098297
 <b>Itching, Formication or Tingling</b>	
Anaemia of Brain.....	4081
Aneurysm .....	41497
Apoplexy .....	903
Arsenic-poisoning .....	901656
Arteritis .....	40497
Arthritism .....	502497

Aura Epileptica .....	2092
Cervical Rib .....	7074694542
Chilblain .....	808642163
Dermatitis .....	40101
Diabetes Mellitus .....	5094
Disseminated Sclerosis .....	90192
Drug Rashes .....	90163101
Eczema .....	3053
Embolism .....	4079
Encephalitis .....	401332
Faecal Accumulation .....	7029
Gout .....	502119
Hemorrhoids .....	2015 (or 2096)
Hyperaemia of Brain.....	409411332
Hypertrophy of Heart.....	40125
Hypochondriasis .....	10976
Hysteria .....	70936
Jaundice .....	40811
Leukorrhoea .....	3071336 (or 332)
Locomotor Ataxy .....	50592
Lymphadenoma .....	302753
Meningeal Haemorrhage, Spinal.....	10427297
Menopause .....	10
Myelitis .....	403453
Nephritis .....	4037 (or 371)
Neurasthenia, Traumatic .....	10924739
Neuritis .....	907651
Pressure on a Nerve.....	501109279
Psoriasis .....	4087
Pyodermatitis Vegetans .....	60210195
Scabies .....	1087101
Sciatica .....	40351935
Seborrhoea .....	4011017
Spinal Apoplexy .....	903279
Spinal Hyperaemia .....	4096297
Spinal Meningitis .....	40279
Syphilitic Spinal Paralysis.....	505542279
Syringomyelia .....	40297
Tetany .....	30785
Thrombosis .....	9098
Tumors of Brain.....	5011332
Tumors of Spinal Cord.....	501 (or 508) 297
Urticaria .....	901547
Uterine Disease .....	40954
Variola .....	403101
Worms .....	908

### Palpitation

Amenorrhoea .....	801954
Anaemia .....	20976
Aneurysm, Thoracic .....	401497769
Angina Pectoris .....	7025
Arterio-sclerosis .....	903
Ascites .....	601753
Chlorosis .....	4095

Cirrhosis of Kidney.....	109137 (or 371)
Dyspepsia, Flatulent .....	608
Epilepsy .....	2092
Exophthalmic Goitre .....	30665
Fatty Heart .....	908925
Fibroid Heart .....	50125
Hysteria .....	70936
Locomotor Ataxy .....	50592
Malformations of Heart.....	1093725
Mediastinal Growth .....	501356
Menopause .....	10
Neurasthenia .....	40739
Ovarian Cyst, Large.....	601338 (or 334)
Paroxysmal Tachycardia .....	50132122810
Pericarditis .....	402587
Pericardium, Adherent .....	1012587
Pernicious Anaemia .....	50465
Pregnancy .....	60239
Tumors, Abdominal .....	5081233
Tympanites .....	607891233
Valvular Diseases .....	501256 (or 259)
Ventricle (Dilated Right).....	3065259

**Heartburn (Cardialgia)**

Cancer of Stomach.....	5032
Dilatation of Stomach.....	306532
Gastralgia .....	40222
Gastritis .....	4032
Indigestion .....	608
Pregnancy .....	60239
Ulcer of Stomach.....	30321
Ulcer of Duodenum.....	30221

**Praecordial Anxiety or Sinking Feeling**

Aneurysm .....	401497
Angina Pectoris .....	7025
Aortitis .....	40789
Arsenic-poisoning .....	901656
Atony of Stomach.....	107832
Cholera .....	90118822
Dilatation of Heart.....	306525
Displacement of Heart.....	808725
Fatty Heart .....	908925
Fibroid Heart .....	50125
Flatulence .....	6078927
Lithaemia .....	407
Melancholia .....	10976
Myocarditis, Acute .....	405992572
Neurasthenia .....	40739
Pericarditis .....	402587
Syphilitic Heart .....	50525
Valvular Disease .....	502256 (or 9)

**Girdle Sensation**

Disseminated Sclerosis .....	90192
Locomotor Ataxy .....	50592

Myelitis, Transverse .....	403453
Spinal Meningitis, Syph.....	505279
Traumatic Spondylitis .....	1092297
Tumors of Cord.....	501 (or 508) 297
<b>Sensation of Local Heat</b>	
Exophthalmic Goitre .....	30665
Influenza .....	308
Irritant-poisoning .....	90148
Locomotor Ataxy .....	50592
Menopause .....	10
Neurasthenia .....	40739
Paralysis Agitans .....	504252
Rectum, Cancer of.....	50851
<b>Sweating, Sensation of</b>	
Syringomyelia .....	40297
<b>Throbbing, Sensation of</b>	
Abscess .....	3042
Anaemia .....	20976
Aneurysm .....	401497
Exophthalmic Goitre .....	30665
Headache, Congestive .....	70962
Heart, Hypertrophy of.....	40125
Hysteria .....	70936
Inflammation, Local .....	40
Migraine .....	70964
Neurasthenia .....	40739
Palpitating Aorta .....	401497789
<b>Sensation of Fullness</b>	
Atony of Stomach.....	1078
Dilatation of Stomach.....	306532
Emphysema of Lung.....	60277 (or 76)
Fatty Degeneration of Heart.....	908925
Gastric Irritation .....	40732
Gastritis, Chronic .....	4032
Goitre, Exophthalmic .....	30665
Hepatic Enlargements .....	40148
Hypertrophy of Heart .....	40125
Hysteria .....	70936
Malaria .....	302
Menopause .....	10
Peritonitis, Chronic .....	401653
Tympanites .....	607891233
<b>Sensation of Weight</b>	
Angina Pectoris .....	7025
Asthma .....	70949
Apoplexy .....	903
Aura Epileptica .....	2092
Cirrhosis of Liver, Hypertrophic.....	109148 (or 487)
Dilatation of Heart.....	306525
Displacement of Heart.....	808725
Dyspepsia .....	608
Endocarditis, Acute .....	403795

Exophthalmic Goitre .....	30665
Faecal Accumulation .....	7029
Flatulence .....	6078927
Gastric Irritation .....	4032
Gastritis, Chronic .....	4032
Lithaemia .....	407
Neurasthenia .....	40739
Neuritis, Multiple .....	70511
Paralysis .....	5042
Stomach, Atony of.....	107832
Stomach, Dilatation of.....	3065321
Syphilitic Liver .....	50548
Trichinosis .....	90837

### Sensation of Bearing Down

Abortion (threatened) .....	90764954
Cervicitis .....	40952
Cervix, Hypertrophied .....	401952
Distension of Bladder.....	306562
Dysmenorrhoea .....	70101
Endometritis, Hypertrophic .....	4097651
Enteroptosis .....	808722
Faecal Accumulation .....	7029
Haemorrhoids .....	2015 (or 2096)
Metritis .....	407651
Ovarian Cyst .....	601338 (or 334)
Prolapsus Uteri .....	8087954
Periproctitis .....	40566851
Prostatitis .....	40999
Rectum, Cancer of.....	50851
Rectum, Ulcer of.....	30851
Retroversion .....	90548
Subinvolution .....	7065954
Tumors, Pelvic .....	508525
Uterine Fibroid .....	501954
Uterine Polypus .....	30795197
Uterus, Congestion of.....	40149554
Uterus, Inversion of.....	4035954

### Sensation of Oppression

Aneurysm, Thoracic .....	401497769
Angina Pectoris .....	7025
Aortitis .....	40789
Asthma, Spasmodic .....	402392
Dyspepsia .....	608
Emphysema of Lung.....	60277 (or 76)
Exophthalmic Goitre .....	30665
Hysteria .....	70936
Mediastinal Tumor .....	501 (or 508) 356
Pericardial Effusion .....	60162587

# VERTIGO

Alcoholism .....	9014004
Aneurysm .....	401497
Antral Abscess .....	302254
Aortic Regurgitation .....	402256
Aortitis .....	40789
Apoplexy .....	903
Arterio-sclerosis .....	9038
Aura epileptica .....	2092
Bulbar Paralysis .....	504286544
Catalepsy .....	90798

**Abdomen** ..... 1233

<b>Acids, Organic</b> .....	451
Acetic .....	45149
Amino .....	4515
Hydrochloric .....	8
Lactic .....	4519
Diacetic .....	4517
Uric .....	4512

**Ampulla of Vater**..... 114

**Anatomy** ..... 7266

**Ankle** 841893

Right .....	172
Left .....	173

**Arms** ..... 131

Right .....	269
Left .....	2691
Forearm .....	2131

**Back** ..... 88

**Bile** ..... 457

Bile Ducts .....	428
Bile Secretions .....	4571

**Blood** ..... 409

**Blood Sugar** ..... 4095-<sup>3</sup>/<sub>10</sub>

Blood Rate (40)9 (or 9)

## DIFFERENTIAL BLOOD COUNT

(All Vibratory Rates in Heavy Type)

**Haemoglobin** ..... 4091

Normal	Normal Percent
3/10 to 6/10	103.0 to 106.0

**Color Index** ..... 98 to 100.0 - 40.973

(To find Color Index: Multiply total number of Erythrocytes by 2; divide Haemoglobin by first two figures of this product; subtract this answer from 100.)

**Erythrocytes** ..... **409229 Men**  
**Erythrocytes** ..... **409226 Women**

Normal  
Men ..... 5/10 5,000,000  
Women ..... 4/10 4,500,000

(Erythrocyte Scale)

1/10	.....	Approximately	1,000,000 to	2,000,000
2/10	.....	Approximately	2,000,000 to	3,000,000
3/10	.....	Approximately	3,000,000 to	4,000,000
4/10	.....	Approximately	4,000,000 to	5,000,000
5/10	.....	Approximately	5,000,000 to	6,000,000
6/10	.....	Approximately	6,000,000 to	7,000,000
7/10	.....	Approximately	7,000,000 to	8,000,000
8/10	.....	Approximately	8,000,000 to	9,000,000
9/10	.....	Approximately	9,000,000 to	10,000,000
10/10	.....	Approximately	10,000,000 to	11,000,000

Normal  
**Normoblasts** ..... None **409107**

**Microblasts (Poikilocytes)** ..... None **409109**

**Macroblasts** ..... None **409106**

**Leukocyte Scale** ..... **3071**

Normal: 5,000 to 9,000 or 7,500 average

1/10	.....	Approximately	4,000
2/10	.....	Approximately	5,000
3/10	.....	Approximately	6,000
4/10	.....	Approximately	7,000
5/10	.....	Approximately	8,000
6/10	.....	Approximately	9,000
7/10	.....	Approximately	10,000
8/10	.....	Approximately	11,000
9/10	.....	Approximately	12,000
10/10	.....	Approximately	13,000

**Polymorphonuclears** ..... **3027**

Normal: 6/10 to 7/10; 65% to 70%

(Polymorphonuclear Scale)

1/10	.....	Approx.	10% of 7500	750
2/10	.....	Approx.	20% of 7500	1500
3/10	.....	Approx.	30% of 7500	2250
4/10	.....	Approx.	40% of 7500	3000
5/10	.....	Approx.	50% of 7500	3750
6/10	.....	Approx.	60% of 7500	4500
7/10	.....	Approx.	70% of 7500	5250
8/10	.....	Approx.	80% of 7500	6000
9/10	.....	Approx.	90% of 7500	6750
10/10	.....	Approx.	100% of 7500	7500

**Lymphocytes, Large and Small** ..... **3029**

Normal: 2/10 to 3/10; 24% to 28% of 7500

(Lymphocyte Scale)

1/10	.....	Approximately	20%	1500
2/10	.....	Approximately	24%	1800
3/10	.....	Approximately	28%	2100
4/10	.....	Approximately	32%	2400
5/10	.....	Approximately	36%	2700
6/10	.....	Approximately	40%	3000



7/10	.....	Approximately 44%	3300
8/10	.....	Approximately 48%	3600
9/10	.....	Approximately 52%	3900
10/10	.....	Approximately 56%	4200

**Large Mononuclears** ..... (3026)

Normal: 1/10 to 4/10; 1% to 4% of 7500  
(Large Mononuclear Scale)

1/10	.....	Approximately 1%	75
2/10	.....	Approximately 2%	150
3/10	.....	Approximately 3%	225
4/10	.....	Approximately 4%	300
5/10	.....	Approximately 5%	375
6/10	.....	Approximately 6%	450
7/10	.....	Approximately 7%	525
8/10	.....	Approximately 8%	600
9/10	.....	Approximately 9%	675
10/10	.....	Approximately 10%	750

**Eosinophils** ..... (3049)

Normal: 1/10 to 4/10; 1% to 4% of 7500  
(Eosinophils Scale)

1/10	.....	Approximately 1%	75
2/10	.....	Approximately 2%	150
3/10	.....	Approximately 3%	225
4/10	.....	Approximately 4%	300
5/10	.....	Approximately 5%	375
6/10	.....	Approximately 6%	450
7/10	.....	Approximately 7%	525
8/10	.....	Approximately 8%	600
9/10	.....	Approximately 9%	675
10/10	.....	Approximately 10%	750

**Myelocytes** ..... (3047)

Normal: None

(Myelocyte Scale)

1/10	.....	Approximately 1%	75
2/10	.....	Approximately 2%	150
3/10	.....	Approximately 3%	225
4/10	.....	Approximately 4%	300
5/10	.....	Approximately 5%	375
6/10	.....	Approximately 6%	450
7/10	.....	Approximately 7%	525
8/10	.....	Approximately 8%	600
9/10	.....	Approximately 9%	675
10/10	.....	Approximately 10%	750

Normal

(Cornils) ..... None 3048

(Ehrlichs) ..... None 3041

**Mast Cells** ..... None 3062

**BONES**

Bones	.....	84
Long	.....	8490
Short	.....	84168
Flat	.....	8432
Irregular	.....	84392

**Arm**

Elbow .....	84115
Humerus .....	84353
Radius .....	84345
Ulna .....	84464
Clavicle .....	84548

**Foot**

Ankle .....	84189 <sup>1/2</sup>
✓ Calcaneum .....	84134
✓ Cuneiform .....	84595
✓ Metatarsus .....	84573
✓ Navicular .....	84621
Talus .....	84262
✓ Toes .....	84422

**Hand**

Fingers .....	84895
Os Capitatum .....	84384
Os Hamatum .....	84264
Os Lunatum .....	84104
Os Multangulum Majus.....	84288
Os Multangulum Minus.....	84434
Os Naviculare .....	84133
Os Triquetrum .....	84367
Pisiform .....	84201
Thumbs .....	84891

**Head**

Antrum .....	84254
Cranium .....	846837
Ethmoid .....	84993
Frontal .....	84596
Hyoid .....	84448
Malar .....	84195
Mandible .....	84872
Mastoid .....	842843
Nasal .....	84484
Occipital .....	841164
Palate .....	841354
Parietal, R. ....	8429
Parietal, L. ....	84291
Sella Turcica .....	84296
Skull .....	84107
Sphenoid .....	84933
Superior Maxillary .....	84864
Temporal .....	84862

*Hard Palate**1354**Soft Palate**1358***Leg**

Femur .....	84114
Fibula .....	84329
Hip (Os Innominatum) Right.....	84479
Hip (Os Innominatum) Left.....	84439
Ilium .....	84374
Ischium .....	84835
Knee .....	84121
Tibia .....	84319

Os Pubis .....	84165
Pelvis .....	84525
Periosteum .....	359
Ribs .....	84542
Scapula .....	84397
Sternum .....	84263
Vertebrae .....	84867
Atlas .....	842823
Cervicle .....	84692
Coccyx .....	84188
Dorsal .....	84183
Lumbar .....	84193
Sacral .....	84854

Bone Marrow .....	3453
<i>Acetabulum (of hip)</i> .....	<i>7465</i>
Joints .....	849
Large Joints (119) .....	100
Large Joints, Ankles (4) .....	1892
Large Joints, Coccyx (3) .....	284
Large Joints, Costal Sterni (14) .....	503
Large Joints, Costal Vertebrae (48) .....	902
Large Joints, Elbows (2) .....	10043
Large Joints, Hip (2) .....	1775
Large Joints, Ilio Sacral (2) .....	923
Large Joints, Knee (4) .....	3343
Large Joints, Shoulders (2) .....	3323
Large Joints, Sterni Clavicle (2) .....	693
Large Joints, Vertebrae (28) .....	546
Large Joints, Wrists (2) .....	10041
Small Joints .....	101
Small Joints, Finger .....	950
Small Joints, Mandible .....	1736
Small Joints, Phalanges .....	360
Small Joints, Toe .....	422

Cardiac Sac .....

Chest .....

**Circulation**

Arteries .....

(All arteries except those here designated  
are 497 plus the rate of the location.)

Aorta .....	789
Aorta, Abdominal .....	1233789
Aorta, Thoracic .....	75789
Coronary, Right .....	492
Coronary, Left .....	4921
Pulmonary, Right .....	534
Pulmonary, Left .....	5341

<b>Blood Vessels</b> .....	2324
<b>Veins</b> .....	494
Hepatic .....	494898
Portal .....	49420
Jugular .....	494727
Pulmonary, Right .....	494734
Pulmonary, Left .....	4947341
Vena Cava, Inferior.....	49433
Vena Cava, Superior.....	49437
<b>Lymph Glands</b> .....	327
Chyli .....	3353
Cisterna Chyli .....	3278
Thoracic Duct .....	327769
<b>Colloidal Tissue</b> .....	1299
<b>Death</b> .....	54
<b>Diaphragm</b> .....	8044
<b>Face</b> .....	10290
<b>Fascia</b> .....	104
<b>Fingers</b> .....	895
<b>Foot</b> .....	2163
<b>Gas</b> .....	6789
Chlorine .....	301
Hydrogen .....	169
Nitrogen .....	721
Oxygen .....	263
<b>Glands</b>	
Axillary Nodes .....	885599
Cervical .....	174
Endocrine .....	259
Hormone .....	3199
Lacteal .....	3232
Lymph Nodes (in general).....	869
Mammillaries .....	829
Milk Duct .....	333
Parotid .....	2795
Salivary .....	589
<b>Glands, Endocrine</b>	
Lymph .....	327
Ovary, Right (External Function).....	336
Ovary, Right (Internal Function).....	338
Ovary, Left (External Function).....	332
Ovary, Left (Internal Function).....	334
Pancreas, Head .....	9972
Pancreas, Tail .....	997
Pancreas, Islands of Langerhans.....	99719
Parathyroid, Upper Right.....	59
Parathyroid, Lower Right .....	69
Parathyroid, Upper Left .....	79
Parathyroid, Lower Left.....	89
Pineal .....	98
Pituitary, Anterior Lobe.....	694
Pituitary, Posterior Lobe.....	698
Prostate .....	999
Spleen .....	465

Suprarenal, Right .....	31072
Suprarenal, Left .....	31078
Testicle, Right (Internal) .....	788
Testicle, Right (External) .....	786
Testicle, Left (Internal) .....	781
Testicle, Left (External) .....	782
Thyroid, Right .....	687
Thyroid, Left .....	6871
Thymus .....	396
Uterus .....	954
<b>Glandular</b> .....	1933
<b>Gums</b> .....	591
<b>Glass</b> .....	8010
<b>Hair</b> .....	1090
<b>Hand, Right</b> .....	26
Left .....	261
<b>Head</b> .....	97
<b>Head, Top of</b> .....	99
<b>Leg, Right</b> .....	42
Left .....	43
<b>Malformation</b> .....	1937
<b>Malposition</b> .....	435
<b>Membranes</b> .....	566
Great Omentum .....	4334
Mesentery .....	815
Mucous .....	976
Serous .....	766
Synovial .....	2008
<b>Menstruation</b> .....	818
Delayed .....	141
Function .....	65
Menopause .....	10
<b>Mental Rates</b>	
Aberration (Functional) .....	5033
Anger .....	3078
Anxiety States .....	90769
Asleep .....	10891
Brain Fag (Overworked Brain) .....	9074
Brain Relaxed .....	60487
Brain Stimuli .....	10091
Cheerful .....	10364
Dementia (Brain) .....	201
Dementia Praecox .....	2016
Depressed .....	10552
Despondent .....	10852
Discomfort .....	1091
Ecstatic .....	80984
Fatigue .....	3067
Fear .....	7031
Forgetfulness .....	80624
Grief .....	8071
Hate .....	8093
Hypersensitive .....	3053

Hysteria .....	70936
Insanity .....	6049
Insomnia .....	80573
Jealousy .....	20153
Malingering .....	4096495
Melancholia .....	610976
Mental Laziness .....	10296
Procrastinating .....	1094
Psychasthenia .....	7039
Self-esteem .....	9015
Selfishness .....	9043
Self-pity .....	7038
Senility .....	3048
Somnolent .....	90692
Spitefulness .....	2082
Stammering .....	20212
Ulterior Motive .....	50768
Vacillating .....	2032
Worry .....	10853

— Good results with fear, depression and disagreeable mental conditions generally.....70316477

*Crude Minerals (834)*

Radium .....	834300
Gold .....	834803
Lead .....	8341609
Aluminum .....	8349799
Antimony .....	834909
Manganese .....	83455
Phosphorus .....	834695
Iodine .....	834884
Sodium .....	83445
Copper .....	83410837
Uranium .....	8349099
Magnesium .....	834871
Silver .....	8343880
Platinum .....	834109
Cobalt .....	8346003
Sulphur .....	834446
Iron .....	834492
Silicon .....	83467
Tin .....	8341184
Carbon .....	83487
Zinc .....	8345009
Arsenic .....	8344999
Potassium .....	83454
Lime .....	8341753
<b>Mineral Salts (Digested) .....</b>	<b>979</b>
<b>Mouth .....</b>	<b>2222</b>
<b>Muscles, Sphincter .....</b>	<b>87</b>
Ani .....	601
Bladder .....	2297
Mouth .....	2222
Rectal .....	228
Urethral .....	430
Vaginal .....	95

**Muscular Structures**

Cartilages .....	154
Cartilages, Ensiform .....	2382
Cartilages, Rib .....	2356
Cartilages, Semilunar .....	9003
Fascia .....	104
Ligamentous System .....	2843
Ligaments .....	854
Muscular System .....	37472
Muscle .....	599
Muscle, Inter-costal .....	356
Muscle, Involuntary .....	59980
Muscle, Voluntary .....	59918
Tendon .....	645
<b>Myopic</b> .....	<b>963647</b>
<b>Nails</b> .....	<b>459</b>
<b>Neck</b> .....	<b>523</b>
<b>Nerve, Median</b> .....	<b>1218</b>
<b>Nerve, Radial</b> .....	<b>1217</b>
<b>Nerve, Ulnar</b> .....	<b>1219</b>
<b>Blocked or Impinged Nerves</b> .....	<b>9063</b>
<b>Nerves</b> .....	<b>1109</b>
Afferent .....	561
Efferent .....	741
Motor .....	865
Sensory .....	759
Sympathetic .....	739
Sympathetic, Cervical Plexus.....	121
Sympathetic, Hypogastric Plexus.....	135
Sympathetic, Pelvic Plexus.....	136
Sympathetic, Pulmonary Plexus.....	139
Sympathetic, Solar Plexus .....	66
<b>Nerves, Cranial</b> .....	<b>2208</b>
Olfactory .....	22081
Optic (See Note A) .....	22082
Oculomotor .....	22083
Trochlear .....	22084
Trigeminus .....	22085
Abducens .....	22086
Facial .....	22087
Acoustic (See Note B) .....	22088
Glossopharyngeal .....	22089
Vagus .....	220810
Spinal Accessory .....	220811
Hypoglossal .....	220812
Auditory Nerve .....	220808
Auditory Center .....	220808

Note A: 2nd Cranial Nerve supports the

- (1) Stomach.
- (2) Mammillaries

Note B: 8th Cranial Nerve, 22088, supports 987, 5 tissues:

1. Fallopian Tubes and Spermatic Cord.
2. Uterus and Prostate.
3. Hearing.
4. Diaphragm via Solar Plexus.
5. Muscles of Shoulder and Neck.

### Additional Functions of the Cranial Nerves

Constricts nerves of spine, throat and eyelids.....	22081
Clears vision .....	22082
Draws muscles of eyes outward and upward and affects teeth.....	22083
Relaxes eyes and entire brain and constricts stomach .....	22084
Inhibits salivary secretion, draws eyes inward.....	22085
Salivary secretion .....	22086
Thought .....	22087
Sleep .....	22088
<b>Nerves, Gasserian - Ganglion.....</b>	<b>10074</b>
<b>Nerves, Phrenic .....</b>	<b>1001096</b>
<b>Nervous System, Motor.....</b>	<b>1633</b>
Sensory .....	142183
Sympathetic .....	1943
<b>Nasal Duct .....</b>	<b>965184</b>
<b>Omentum .....</b>	<b>4334</b>
<b>Organs</b>	
Appendix .....	86
Bladder .....	62
Brain .....	1332
Arachnoid .....	1909
Cerebellum .....	231
Cerebrum, Right .....	29
Cerebrum, Left .....	291
Cortex .....	9979
Medulla and Cervicals.....	44
Meninges .....	279
Spinal Cord .....	297
Breasts (Mammae), Right.....	73
Left .....	74
Bronchial Tube, Right.....	2392
Left .....	2391
Colon .....	27
Caecum .....	82
Hepatic Flexure .....	84
Ileo-caecal valve .....	827
Rectum .....	851
Sigmoid .....	85
Splenic Flexure .....	81
Transverse .....	83



Cord, Spinal .....	297
Ears .....	910
Right .....	9
Left .....	91
Auditory Nerve .....	8080
Ear Wax .....	46
Eustachian Tube .....	3226
External .....	1337
Hearing .....	6766
Hearing Centers .....	8080
Middle Ear .....	13372
Semi-circular Canal .....	2855
Stapes, Incus, and Malleus.....	122
Tympani .....	4433
Eye, Right .....	3
Left .....	31
Conjunctiva, Right .....	3776
Conjunctiva, Left .....	31776
Cornea, Right .....	33988
Cornea, Left .....	313988
Eyelid, Right .....	3979
Eyelid, Left .....	31979
Iris, Right .....	32534
Iris, Left .....	312534
Lacrimal Duct, Right.....	351
Lacrimal Duct, Left.....	3151
Lacrimal Sac, Right.....	3953
Lacrimal Sac, Left .....	31953
Lacus Lacrimalis, Right.....	302
Lacus Lacrimalis, Left.....	3102
(Triangular Space)	
Lens, Right .....	3777
Lens, Left .....	31777
Optic Nerve, Right .....	3647
Optic Nerve, Left .....	31647
Palpebral, Right .....	3109
Palpebral, Left .....	31109
Palpebral, Commissures, Right.....	3104
Palpebral, Commissures, Left .....	31104
Punctum Lacrimalis, Right.....	304
Punctum Lacrimalis, Left.....	3104
(Mouth of Lacrimal Duct)	
Retina, Right .....	3709
Retina, Left .....	31709
Sight, Right .....	310
Sight, Left .....	311
Tarsal Glands, Right.....	307
Tarsal Glands, Left.....	3107
Vision, Right .....	3986
Vision, Left .....	31986
(Compare with Function of Opposite Nerve)	
Female Organs	
Bartholin's Gland, Right.....	93
Left.....	931

**Kresote -  
Carbolic acid**

901.8074

901597

Conium .....	9015239
Ergotin .....	90110103
Ferrum .....	901493
Glycerine .....	90118
Henna .....	901145
Iodide .....	901884
Lactate .....	901452
Lactose .....	901138
Lysol .....	90135164
Magnesium .....	901871
Merc. Dulcis .....	9017046
Morphine .....	9014056
Nucleic Acid .....	901473
Novocain .....	9012064
Peroxide .....	901566
Phosphorus .....	901695
Potassium Bicarbonate .....	90183454
Sodium .....	90145
Sodium Bicarbonate .....	90183445
Thyroid Extract .....	901965127
Fat .....	901989
Fibrin .....	9011956
Gas .....	9016789
Irritants .....	90148
Ivy .....	901134
Oak .....	9011188
Organic .....	9011011
Phosphate .....	90110029
Poison Crystals .....	901588
Poison to Humans .....	90163
Protein .....	901673
Snake .....	901908
Vitamin .....	9019009
Water .....	9011008
Whiskey .....	9012545
<b>Poison Toxin, Itching Skin .....</b>	<b>90172</b>
<b>Pregnancy .....</b>	<b>60239</b>
Male .....	876 (or 19)
Female .....	875 (or 18)
Embryo (Human Pregnancy) .....	379
<b>Prognosis as to Disease .....</b>	<b>7076</b>
<b>Prognosis as to Patient .....</b>	<b>6043</b>
(Add either of above rates to VR below)	
Fair .....	39
Good .....	37
Poor .....	84
(Can have a curable disease, yet not have a curable patient.)	
<b>Salt .....</b>	<b>515</b>
<b>Scalp .....</b>	<b>624</b>

389

(389)

<b>Secretions</b> .....	640
Appendix .....	960
Bile .....	4571
Glycogen (Hepatic) .....	78
Hormone .....	3199
Hydrochloric Acid .....	8
Intestinal .....	97
Mammillaries .....	559
Medulla .....	985
Pancreatic .....	997
Parathyroid .....	598
Parotid .....	715
Periomentum .....	82
Saliva .....	961
Secretin of the Duodenum and Jejunum.....	4719
Secretin, Gastric .....	47192
Spermatazoan .....	19
Splenic .....	465
Sub-lingual .....	103
Sub-maxillary .....	219
Thyroxin .....	687
Tongue Mucus .....	796
 <b>Sex</b> .....	
Female .....	18
Male .....	19
 <b>Sex Centers</b> .....	872
1. Spinal Cord .....	297
2. Cerebellum .....	231
3. Cerebrum .....	1098
To find percentage of male and female in each individual register the male or fe- male sex rate and check function on the 9th dial. The percentage will register in tenths. In registering male or female it will be necessary to combine sex rate with gonads (internal function).	
 <b>Shoulders</b> .....	753
 <b>Sinuses</b> .....	36
Antrum .....	254
Brain .....	9759
Ethmoid .....	993
Frontal .....	133
Mastoid .....	2843
 <b>Skin</b> .....	101
 <b>Sneezing</b> .....	623
 <b>Solar Plexus</b> .....	66
 <b>Teeth</b> .....	499
Eye (Upper Canine) .....	246
Incisors (4 Front) .....	245
Molars (Large Grinders) .....	241
Premolars (Bicuspid) .....	244
Wisdom .....	226

Sphenoidal Sinus  
 RT. 933  
 Lt. 9331

Temperature .....	450
Thigh	
Right .....	1194
Left .....	11941
Tissue .....	2774
Toes .....	422
Tongue .....	1296
Trauma .....	192 1092

last 3 dialys on 10 then down (odd figures)

Specific Gravity .....	(6098710)
Reaction, Acid .....	609353
Reaction, Alkaline .....	609356
Urea .....	609567

Solids (To find amount of solids, multiply the amount of urine voided—in ounces—in 24 hours by the last two figures of the Specific Gravity; add to this product 1/10 of itself and the result will be in grains).

Treat Uremia  
506, 37, 371  
+ sweet spirits  
of nitre.  
(506 = Uric Acid)  
(37, 371 = Kidneys)  
Urin - 609

Bile Pigment .....	60942	0
Sugar .....	60957	0
Albumen .....	60977	0
Indican .....	60953	0
Acetone .....	60969	0
Diacetic Acid .....	60997	0
Tube Casts .....	60923	0
Epithelial Cells .....	609101	0
Pus Corpuscles .....	60960	0
Red Blood Corpuscles.....	60949226	409?
Leukocytes (White Blood Corpuscles).....	609371	0
Spermatozoa .....	609784	1
Bacteria .....	6091280	5
Mucus Threads .....	609972	3
Uric Acid Crystals.....	609562	1
Calcium Oxalate .....	609252	.2
Calcium Phosphate .....	609254	1
Urates (Amorphous) .....	60995	1

Vitality, Female .....	409711
Vitality, Male .....	409712
(Normal is from 1 point to 4 points. Anything below is sub-normal.)	
Vitamin .....	30339

Blank

PART C  
SOME GENERAL OBSERVATIONS  
AND INSTRUCTIONS

CANCER THEORY

Not enough Life Force to a part of the body causes congestion of electrons which forms a tumor. The red blood flows into the part, which part is impinged or obstructed, and when the venous blood tries to come out it cannot do so. Venous blood has carbonic acid in it, which is corrosive. Venous blood also needs oxygen to turn it over into an alkaline state or to aerate it back into red blood again.

When it is obstructed it tries to reach oxygen and follows the capillaries which connect it with the lymphatics. The acid condition meets the alkaline one in the lymphatics, they become acid and an imbalance takes place in the blood circulation and the lymph. While the general condition of blood serum is alkaline it repels (electronically speaking) the alkaline blood, and deterioration takes place.

Thus Cancer is an imbalanced condition of the red blood, which is alkaline, the venous blood which is acid, and the lymphatics, which are alkaline. The protonic action is acid and positive and the electronic action is negative and alkaline, thus a growth of too many electrons per protonic attraction causes a growth of cell structure. Only the continuous flow of the Life Force, which is protonic in nature, can equalize the cell electronic balance.

THE LAW OF THE CIRCLE

All energy of the universe belongs to what is known as the Law of the Circle. In physics the same thing is stated when it is said "all energy returns to its source, therefore all energy goes out from the body and returns to the body naturally".

This HVR instrument acts as a monitor or direction station. It directs the energy by focusing it on the part which is low or high in function, or needs balancing.

The reason disease is thrown off, the tissues of the body are brought up to a positive polarity and since the body is made up of polarized atoms, it comes under the head of electro-magnetic energy, magnetically speaking. Like poles repel and unlike poles attract, and bac-

teria is the same polarity as the body in health and is thrown off where the body is brought up to its normal polarity. When feeling is sent from any person it unerringly returns.

#### NOTES AND RATES

If you cut your finger you do not heal it neither does the doctor. The healing comes from within, from that radiant Life Force, which is the only force that has the power to rebuild cells. That is the only energy we use in making a diagnosis, in taking pictures, in treatment, sending the patient's Life Force to the parts which need rebuilding.

Check spleen for trembling of hands and hyperthyroidism.

Uric acid and calcium out of balance in cataracts which come from thyroid and parathyroid; check small intestines for 506 and 20.

Use 901-2-6 for adonitis, for children who have adonoids; also check and treat thymus and thyroid.

Spider bite rate in Atlas is for black widow. Place bottle of household ammonia on foot pads.

For Parkinson's disease treat suprarenals.

Flatulence (gas) at any time regardless of what or when anyone eats, comes from the kidneys.

Contraction of portal veins causes hemorrhoids. Also check head of pancreas.

When H.C.L. is too low, suggest one-half teaspoon of lemon in water before meals to start it flowing.

We never treat areas where X-ray or radium has been used, as the nucleus of the cell has been killed.

We never treat chronic alcoholics or drug addicts. It is not they who wish to be cured, but their families' wish, and the sensitive Life Force will not penetrate drugs, aloe or alcohol.

When there is low uria, check liver.

Unidentified bacteria in urine gives an inner nervousness.

Use aloe in well of instrument if patient has any drug (aspirin, sleeping medicine, glandular extracts, etc.) in system, so as to procure correct reading.

When Islands of Langerhans are low, check for diabetes.

Check for parasites when Eosinophils are high in blood count.

Use 906-3-2-2-0-8-0-10 (Impingement of 10th cranial nerve) for migraine headaches.

When tonsils are bad, check for trouble in stomach and intestines.

Try 906-3-2-7-7 (Impingement of epiglottis) for hiccoughs.

When blood pressure is low, check for embolism.

When indican is high in urine, it generally means heart trouble of long standing.

The meter shows energy expended over the nervous system.

The color of dress makes difference in diagnosis. Red gives a cancer reaction.

When parathyroids are low it means poor circulation of minerals.

Try 506(uric acid) 20 (calcium) or 0-1-6-3 (combination of minerals) for trouble in joints, or in any part which is low.

Thyroid increases oxidation.

Parathyroid builds fat, controls toxins.

Thyroid burns up fat and waste.

Adrenals furnish calcium for parathyroids to regulate.

Parathyroids closely related to pancreas.

For low blood pressure use:

0-6-9-8-4-9-7

0-6-9-8-4-9-4

0-6-9-8-1-3-3-2

An attached blood clot is a thrombus.

703-1-6-4-7-7, the Fear rate. A good rate to use for ten minutes on fearful patients before giving treatment.

When calcium phosphates are thrown off in urine, nerves are bad.

Pain above diaphragm could be 302-3-5-6. Abscess in mediastinum.

An unattached blood clot or foreign body is an embolism (including an air bubble).



Low coronary generally means heart trouble of long standing.

Low pituitary often causes epilepsy, but especially check diseases of pineal.

High polys in blood count, check for abscess in system, in appendix, and low area 68-4 intestinal obstruction.

When hemoglobin is high look for pernicious anemia, check for 50 in spleen and liver.

For obscure disease check 306-5 (dilation, 88-7 (prolapsis). Through low areas do not use those two rates for treatment. Use 0-6-9-8 through areas they were found in, so as to give tone.

High lymphatics when polys are low gives leucopenia. Check liver or chlorosis in young girls.

Treat cortex of suprarenals for nervousness, also hot flashes.

For asthma try 40-7-8-9-8, which is inflammation of aorta; also treat suprarenals.

Anterior pituitary controls sex, long bones and skin.

Posterior pituitary increases pituitrin in system, which feeds nerves through spinal cord and brings tone to muscles.

Do not treat directly into the heart.

Over-function of thyroid contracts duodenum.

0-(8-6-5) (6-5-1) motor nerves through endometrium, for help in child birth.

When lymphatics are high, check spleen, try 502 and 505 through area.

When there is bile pigment in urine check liver.

Our blood pressure is taken on entire body and not on brachial artery.

When ankles swell, check pancreas.

After patient has been given novocain for tooth extraction, treat 409-5-9-1, (blood thru gums).

For nervous stomach use for treatment 0-7-3-9-3-2-1.

When polys are low there is trouble in blood-forming organs.

When epithelial cells are high in urine it is a check back on real pathology.

When kidney trouble is difficult to control treat  
0-6-9-8-3-10-7-2-2-4-6-8.

The cause of blood sugar, liver, anterior pituitary and pancreas, these organs are not taking care of blood sugar.

90-f-2-0-1 for food poisoning, add organs where it is likely to be found.

For stye on eye. Check pancreas and treat.

Right kidney gives forth hormone which activates elimination, kidneys included.

Left kidney gives forth hormone which activates assimilation, kidneys included.

When there is trouble in right kidney, people are apt to be heavy, as left kidney would be assimilating and not eliminating.

Always take a full case history. All information is necessary toward a complete diagnosis.

#### REACTIONARY PAINS

Pain in right and left sides of head, near top, comes from kidneys. Pain in right shoulder, top, comes from liver. Left shoulder, top, ovaries. Upper arms, from kidneys. Upper legs, from uterus, ovary or prostate. Front of head, from stomach, small intestine. Base of head, from rectum, uterus, prostate. Right side base of head, from gall bladder. Above forehead, slightly to left, check pancreas. Shooting pains in chest, check pancreas. Pain in shin bone, comes from uterus or prostate.

Treatment for varicose veins:

0-6-9-8-5-9-9

0-6-9-8-4-9-4

309-5-9-9-4-9-4

#### VITAMIN RATES

Measure on last dial, when it registers 5 or below, suggest foods rich in those vitamins.

A-33-3-9-(9-9)

B " " " (9-0-0-9)

C " " " (3-4-4-4)

D " " " (2-8-0-1)

E " " " (5)

F " " " (4-0-0-4)

G " " " (6-2-9)

Try 609 (urine) through areas where worms are found.

Check spleen when polys are low and sympathetics are high.

Sugar and acetone in urine goes back to liver. It is indication of hepatic diabetes.

Hyperthyroid often causes sugar to be thrown off in urine.

Add 9 to uterus rate (9-5-4- (-9 for testing uterus after menopause.

Trouble in knees comes from ovaries. Treat ovaries.

0-8-3-2-1 for nausea.

Do not treat worms. It makes them grow.

#### USING BAR MAGNET FOR POLARITY

To test polarity of remedy use bar magnet; all dials at 0; disconnect patient, place remedy in well, and with treatment cord test whether it is positive or negative. To test polarity of patient, patient has feet on foot pads, all dials at 0, test with bar magnet whether positive or negative.

When pathology registers in lymph (3-2-7), test cysterni chyli for trouble (3-2-7-8).

Always clear abscess or strep. out of T.B. areas before treating for T.B.

Use 0-5-9-6-9-7-9-8-9 (parathyroids) for hemorrhage anywhere in body.

Use 50-7-9-10 (auto intoxication rate) for heavy feeling.

Pain extending from front to back of abdomen. Check gall bladder for trouble.

When erythrocytes are low, check for anemia.

#### RETENTION OF URINE

1 quart of boiling water poured over 4 sliced lemons, 1 teaspoon of cream of tartar, 2 teaspoons of epsom salts, honey to taste, and drink.

#### COLDS

Flu 308-2-3-9-1-7-7 (L. bronchial and L. lung)  
308-2-3-9-2-7-6 (R. bronchial and R. Lung)  
308-2-5-4-3-6 (antrum and sinus)  
308-2-2-2-7-2-3 (Entire intestine and both kidneys)  
308-4-8-4-8-7-3-8 (Liver and gall bladder)

Use 21-7 in areas where trouble is stubborn.  
49-3-3-8-3-3-4 (ovaries) for menstrual colic.  
Sarcoma can become malignant.

To normalize White Blood Count, as in fevers:  
Treat five minutes on each rate to normalize temperature.

30-2-7-0-0-0-0-0-7  
30-2-9-0-0-0-0-0-3  
30-2-6-0-0-0-0-0-4  
30-4-9-0-0-0-0-0-4  
30-4-7-0-0-0-0-0-0  
30-6-2-0-0-0-0-0-0

Magnesium phosphate (opposite of iron) relaxes.  
Iron contracts.

We use "atomic rates" in Atlas to check obscure skin diseases, then treat with mineral rates found to be deficient.

We check for aneurysm when there is palpitation of the aorta.

901 -6-3 drub poison rate, then add the rate for different drugs.

Check for 807-9-9 (blood clot) in paralysis.

In squinting of eyes there must be an impingement of 3rd cranial nerve.

Our blood pressure rates given in the Atlas are findings on entire body. If you wish to take pressure on brachial artery, the rates are 407-5-1-4-2 for systolic and 407-5-1-4-9 for diastolic.

Do not treat hypertrophy of the heart.

409-5 is rate for blood sugar, with reading on last dial, 3/10 as normal.

Do not treat endocarditis. Pericarditis can be treated, also valvular conditions.

Only treat 2 rates (a 3rd when necessary) beside the glands at each treatment. Never treat a rate outside of glands less than 10 minutes.

In treatment old cells are thrown off, the new cells come in at a higher rate of vibration, amplified and speeded up by the instrument. Block tin also acts as a condenser.

#### SPECIAL FOOT PADS

We use 24 karat gold electrode and sterling silver footpads for cancer and sarcoma. The gold brings the

blood to areas treated, thus dissipating the disease. Never use gold where there is hemorrhage or high blood pressure, with only one exception, hemorrhage of the uterus and breast. Treat endometrium (6-5-1) when there is hemorrhage in uterus, which would be treating the cause.

Right side of nose when overworked is over stimulated, effecting the nerves. Left side of nose affects blood stream and heart.

T.B. is generally foundation of sarcoma, usually acting through lymphatics.

#### THE DETECTOR OR RUBBING PLATE

In getting our reaction the timing must be right and not too fast, or the electrons "bunch up", giving a continuous reaction. When energy passes through condenser to upper plate, its polarity is changed and it meets flow of electrons being stimulated by finger, with finger stall, and the two short; even as the positive and negative energy in a light bulb come together and short, forming a lite.

We build up electrons of atoms in the cell and health ensues. Disease is the lack of, or too many electrons in the atoms of the cell, our instrument normalizes it.

When there is chronic coughing check heart, check for thrombus in arteries and veins, also in lungs. Check for trouble in luschkas (or coccygeal) gland as it affects the lungs, and asthma, naturally look for disease in bronchial, pharnyx and larnyx.

When there is noise in ear, check for wax 406, cystic fluid 601; also there could be a slight fracture in the semi-circular canal 907-2-8-5-5. Check for aneurysm in arteries and veins of head. 405-2 (aneurysm in 409-4 (veins, in 2-9 or 2-9-1, or 9-9 or 4-4. Also 405-2 (4-9-7) in 2-9 or 2-9-1 or 9-9 or 4-4.

Check for aneurysm when there is heavy throbbing anywhere in body.

When veins or arteries are low in function, check for arterial sclerosis 903, contraction 207, dilation 306-5, thrombosis 909-8, or hydrated cyst 302-9-1 in veins or arteries.

When throat is NOT sore yet there are painful and swollen glands check for congested lymphatics.

Gums which are blue, check for lead poisoning, also for lead poisoning in other parts of the body.

## QUESTIONS AND ANSWERS

Q: When one finds, eg Thyroid, as an originating cause, and 302, 60, and 402 there, how does one decide on which of these rates to begin treatment?

A: Always use the most acute condition, 302, first, then the next, which would be 60, and then the 402.

Q: Mentioned in the book, a case in which trichinae were treated on Homo-Vibra Ray. How was this done?

A: By treating the tissue structure with the instrument and the trichinae with homeopathic medicine.

Q: How does one distinguish 508 sarcoma from 508 obstruction, etc, similarly with 501?

A: 508 is sarcoma but obstruction rate is different unless the 508 is the obstruction, then measure on the last dial the amount in order to designate the amount in area.

Q: If you have a case of caries of the bone, and have got rid of the active trouble, can anything be done to help new bone formation?

A: The treatment of caries rate directs the Life Force which is always pure into the part and holds it focused there and produces rebuilding into the part.

Q: Patient with open scirrhus of breast, no shtick now for 50, but marked on 70194, should one treat on the latter rate, or treat for ulcer only?

A: Always check patient with breast trouble (as well as rheumatism of the knees) on the R. 3-3-3 and L. 3-3-3-1 (corpus luteum), which is the same as milk ducts in the breast, and treat the same trouble there to heal breasts, as well as disease found in breasts.

Q: Have you come to any decision on the question of using an aerial for broadcasting?

A: It is very beneficial, also we are using 24 K. gold for electrodes and sterling silver for footpads, and find it very successful for 50.

Q: In using rate for sex. With the corresponding gland rate, what is the exact procedure to determine sex?

A: Use 8-7-5 with blood 409-8-7-5 for female, 409-8-7-6 for male; with glands it is 7-8-8 or 7-8-1 with male, 3-3-4 or 3-3-8 for female. Checking parentage rate, put rate 10-4-1-4 (7-8-8) right, 10-4-1-4 (7-8-1) left; with blood of child to find father, 3-3-8 or 3-3-6 for mother, use this with race rates for parentage.

## MICROBES

Paratyphoids A. 10-1-6-9-1  
Paratyphoids B. 10-1-6-9-2  
Acne 90-8-3  
Strep. haemolyticus 405-6-2  
Gaertner 602-4  
Whelchii 10-5-6-5-5

## OTHER RATES

Blood urea 409-7-5-6-7  
Blood calcium 409-7-2-0  
Blood cholesterol 409-7-1-6-9  
B. Coli toxins 301  
Chemical poisons, 901 plus any chemical rate  
Vincent's angina 607  
Alopecii areata 20-3-9  
Round worm 90-8-0-5-1  
New mental rate, eg paranoia, 70-1-1-6-9-1

When there is pain in the knees, check function of 3-3-3 (3-3-3-1) which are right and left corpus luteum, also 3-3 and 3-3-1, the right and left oophoron ducts. Also a part of the ovary. Then find disease in the part which is low in function; if right knee will generally find trouble in R. corpus luteum, or R. oophoron.

## KIDNEYS

Right kidney eliminates. The right kidney gives forth a hormone which helps to produce elimination of waste products from the body.

The left kidney assimilates. The left kidney produces a hormone which controls assimilation of the food products of the body.

When the cells in the right kidney are not functioning in these cells, then patient will be heavy through abdomen. If the cells in the left kidney are not functioning patient will be thin.

## LUSCHKAS GLAND 727

There is a gland in the rectum which lubricates and acts the same in the human body as the oil sack in the tail of a chicken. It has been operated upon many times and called a "deep fissure". It is situated at the end of the sympathetic system.

When it is clogged it produces such things as asthma, heart ailments, throat conditions, basal headaches, con-

stipation, lung conditions, etc. This has been proved back by the release of these conditions through cleaning it out by operation. However, this is only temporary, it soon fills up again since the cause of the original obstruction has not been removed. Rate for the Luschkas gland is 7-2-7.

#### THE FOURTH STATE OF MATTER, PLASMA

First, energy (Plasma) is brought down into a gas. Gas comes into body and becomes a liquid, goes then through a gelatinous stage, then through a calcification or crystallization stage. After death, from calcification or crystallization to gelatinous stage, then into gas stage (which one smells) and back to etheric stage from which it came.

The red cells, white cells, blood platelets, salts in the blood, etc. (all of these things are taken into consideration in blood transfusion, but it is the energy which activates all this in the plasma that we are speaking of) belong to the body and return to the earth with the body. While the energy which activates this returns to the ether from which it came. "It" being a form of Light made of electrons which are now being used in the electronic force field which acts the same as a lens, either in a microscope or in television, and is now being used for scanning in television in England. We have been using it since 1935 when we made our photographic instrument.

#### RATES TO MEMORIZE

0-1-6-3	Minerals
0-5	Acidosis
10-4-2-7	Hemorrhage
10-4-8	Hernia
10-9-3-7	Malformed
10-9-1	Cirrhosis
10-9-2	Trauma
10-9-5-4	Menopause
10-1	Adhesions
10-2	Pin worms
20	Calcium
201-7	Pneumococcus
207	Contraction
30	Ulceration
301	Colon bacillus
302	Abscess
304	Staph
306-5	Dilation
307-5-1	Polypoids
308	Flu



309	Carcinoma toxins
40	Inflamation
402	T.B.
403-5	Malposition
406	Ear wax
406-8-7-9-2	Obsession
407	Acidity
50	Carcinoma
501	Fibroma
501-9-9	Amyloid
502	Gonorrhoea
503	Goitre
505	Syphilis (Lues)
506	Uric acid
507	Inherited lues
60	Strep
601	Cystic Fluid
70	Pain
808-7	Prolapsis
901	Poison rate
901-2-0-1	Food poison
901-6-3	Drug poison
903	Arterio sclerosis
4-3-3-4	Greater omentum
5-9-1	Gums
5-9-9	Muscles
9-8-7	R. Psoas
9-8-7-1	S. Psoas
6-2	Bladder
6-6-8	Urethra
2-2-2-7	Intestines as a whole
9-7-3	R. Fallopian
9-7-2	L. Fallopian
3-2-2-6	R. Eustachian
3-2-2-6-1	L. Eustachian
3-5-6-8	Perineum
3-5-9	Periosteum
7-5-8	Peritoneum
3-4-5-3	Bone marrow
3-2-7-8	Cysterni chyli
9-5	Vagina
9-5-2	Cervix
3-5-6	Mediostinum
2-3	Both kidneys
7-2-7	Luschkas or coccygeal gland
6-5-1	Endometrium
2-9	R. side of head
2-9-1	L. side of head
9-9	Top of head
4-4	Base of head
72-7	Barium meal

Dengue. . . . . 10 - 4  
(327-3278-3279)

SHOTS

Typhoid. . . . . 80-7-8  
Small Pox . . . . . 40-5-8  
Dyphtheria and Tetanus. . . . . 90-9-8-0  
Polio. . . . . 20-6-9-2  
Universal Disease V.R. . . . . 10-7-6-2-2-10-3-5-2  
Typhoid (as disease, not shots) 20-5-8

Blank

# INDEX

	Page
Abdomen .....	68
Abdomen, Pain in.....	29-35
Abdominal Aneurysm.....	23, 25, 28, 29, 32, 34, 36, 40, 41, 44
Abdominal Angina .....	29, 39, 40
Abdominal Cancer .....	32
Abdominal Colic .....	42
Abdominal Haemorrhage .....	10
Abdominal Hernia .....	10, 12, 30
Abdominal Tenderness.....	46-47
Abdominal Tumor .....	26, 34, 36, 38, 65
Abdominal Wall, Abscess of .....	46
Abducens .....	76
Aberration, Functional .....	10, 74
Abortion.....	16, 18, 31, 67
Abscess .....	66
Abdominal Wall, 46; Alveolar, 21, 22; Antral, 19, 68; Brain, 20; Bursting into Ear, 48; Cerebral, 10; Ear, 47; Gastric, 10; Hepatic, 27, 35, 45; Ischio-rectal, 33, 34, 47; Liver, 29, 45; Lumbar, 25, 36, 44; Local, 42; Mammary, 26, 45; Mastoid, 19, 21, 43; Mediastinal, 26, 28, 44; Neck, 22; Parotid, 48; Pelvic, 18, 30, 41, 42; Perinaeal, 25, 33; Perinephric, 27, 28, 44; Peritonaal, 30; Post-pharyngeal, 23, 44, 61; Prostatic, 33, 34, 47; Pulmonary, 41; Pulp, 22; Rectal, 25; Retro-mammary, 26; Sac, 54, 55; Septum, 61; Spinal, 31; Spleen, 46; Sub-phrenic, 27, 28, 29, 32, 43, 44; Tuberculous, 26; Urethral, 47	
Acetic Acid .....	68
Acetone .....	83
Acetonemia .....	10
Acetonuria .....	10
Achylia Gastrica .....	32
Acid Reaction, Urinalysis.....	83
Acidity .....	10
Acidity, Sub (Stomach).....	10
Acidosis .....	10
Acids .....	68
Acne Rosacea .....	60
Aconite Poisoning .....	23, 80
Acoustic Atrophy .....	10
Acoustic Nerve .....	76
Acromegaly .....	15, 59
Actinomyces .....	22, 45
Addison's Disease.....	15, 20, 29, 46, 47, 54
Adenitis .....	10
Adenoids.....	18, 19, 49, 60, 61, 62
Adenoma Internum .....	16
Adhesions .....	10
Gastro-cholecystic, 29; Intestinal, 29; Pelvic, 15; Peritonaal 32, 38	
Afferent Nerves .....	76
African Sleeping Sickness.....	10
Ague.....	20, 58, 62
Albumen .....	83
Albumen Poisoning .....	80
Albuminuria .....	10
Alcohol—	
Action of 57; Poisoning, 80; Toxins, 13	
Alcoholism.....	15, 16, 20, 37, 46, 50, 54, 57, 59, 60, 62, 68
Alkaline Reaction, Urinalysis.....	83
Aluminum .....	75
Alveolar Abscess .....	21, 22
Amaurosis .....	56, 57, 59-60
Amblyopia .....	59
Amenorrhoea.....	15, 20, 30, 51, 59, 60, 62, 64
Amentia .....	10
Amnesia .....	10
Amino Acid .....	68

(4095)

Actinimycosis  
see Glanders  
(Ray Fungus)

Aids p.10

	Page
Amoeba .....	10
Amoeba Dysenterica .....	11, 31
Ampulla of Vater .....	68
Amyloid Disease .....	10
Amyloid Tissue Infiltration .....	10
Amyotrophic Lat. Sclerosis .....	35
Anaemia .....	15, 17, 18, 20, 21, 27, 28, 37, 47, 51, 54, 56, 62, 64, 66
Arterial, 10; Brain, 50, 56, 57, 58, 59, 63; Pernicious, 33, 49, 62, 65; Splenic, 45	
Anal Fissure .....	17, 24, 33, 34
Anasarca .....	51
Anatomy .....	68
Aneurysm .....	27, 28, 39, 65, 66, 68
Abdominal, 23, 25, 28, 29, 32, 34, 36, 40, 41, 44; Aortic, 10, 56, 57; Ascending Aorta, 40; Carotid, 10, 11; Cerebral, 50; Cirroid, 48, 63; Descending Aorta, 23, 26; Descending Thoracic, 41; Femoral or Popliteal, 36; Heart, 27; Hepatic, 40; Innominate, 21, 23, 35, 40, 56; Orbit, 55; Pericardium, 27; Subclavian, 35; Thoracic, 26, 64, 67	
Aneuria .....	10
Aneurysmal Prominence .....	45
Anger .....	74
Anger Toxins .....	13
Angina, Abdominal .....	29, 39, 40
Angina, Oesophageal .....	40
Angina Pectoris .....	26, 27, 35, 39, 40, 43, 45, 64, 65, 66, 67
Angioma (See Angioma)	
Angioma, Ear .....	48
Angioma, Nose .....	62
Angioneurotic Oedema .....	51
Ani Muscle .....	75
Ankle (Bone) .....	71
Ankle Joints .....	72
Ankles .....	68
Ankylosis .....	10
Anorexia Nervosa .....	15
Anteflexion .....	15, 16, 17
Anthrax .....	10
Antimony .....	75
Antral Abscess .....	19, 68
Antrum—	
Bone, 71; Disease of, 22; Distended, 61; Empyema of, 59, 61; Sinus, 82; Tumor of, 56	
Anxiety States .....	10, 74
Aorta .....	72
Abdominal, 72; Ascending, Aneurysm of, 40; Descending, Aneurysm of, 23, 26; Palpitating, 66; Thoracic, 72; Stenosis, 10	
Aortic Aneurysm .....	10, 56, 57
Aortic Cusp, Rupture of .....	27
Aortic Disease .....	35
Aortic Insufficiency .....	62
Aortic Regurgitation .....	27, 32, 40, 56, 68
Aortic Valve .....	79
Aortitis .....	26, 40, 65, 67, 68
Aphasia .....	10
Aphasia, Hysterical .....	10
Apoplexy .....	20, 50, 52, 55, 56, 57, 58, 63, 66, 68
Apoplexy, Spinal .....	23, 24, 27, 38, 44, 63, 64
Appendicitis .....	29, 31, 38, 39, 40, 42, 44, 46, 63
Appendicitis Larvata .....	29, 42, 46
Appendicular Colic .....	31, 40
Appendix .....	77
Appendix Secretions .....	82
Appetite (Poison) .....	80
Arachnoid .....	77
Arcus Senilis .....	53
Arm, Pain in .....	35-36
Arms .....	68
Bones of, 71; Numbness of, 12	

treat  
Luschka's  
Gland 727

	Page
Arrhythmias, Cardiac .....	10
Arsenic .....	75
Arsenic Poisoning..... 20, 27, 29, 41, 46, 51, 59, 61, 63, 65,	80
Arsenicism .....	62
Arterial Anaemia .....	10
Arterial Contusion .....	10
Arteries .....	72
Arterio-sclerosis..... 50, 53, 62, 64,	68
Arteritis .....	63
Artery, Sup. Mesenteric, Embolism of.....	32
Arthritis—	
Crico-arytenoid, 23; Gonorrhoeal, 37, 39, 42, 43; Pneu-	
mococcal, 39; Post-febrile, 39; Rheumatoid, 36, 39, 42, 44,	
49, 55, 58	
Arthritism .....	63
Articular Fever .....	10
Ascending Paralysis, Acute.....	52
Ascites .....	64
Asleep .....	74
Asthma..... 20, 45, 54, 55, 60, 61, 66,	67
Astigmatism .....	58
Ataxic Paraplegia .....	24
Atlas .....	72
Atonic Dyspepsia .....	35
Atony of Stomach..... 20, 26, 28, 29, 35, 40, 65, 66,	67
Atrophic Emphysema .....	10
Atrophy .....	10
Acute, Yellow, 17, 28, 29, 45, 46, 56, 63; Acoustic, 10;	
Brain, 49, 59; Muscular, Progressive, 35, 36, 38; Optic, 58;	
Uterus, 15	
Auditory Center .....	76
Auditory Neuritis .....	49
Auditory Nerve .....	76, 78
Aura Epileptica..... 20, 50, 58, 63, 64, 66,	68
Aural Polypi .....	49, 50
Auricles, Absent .....	47
Auricles, Fistulous .....	47
Autophonia .....	50
Axillary Nodes .....	73
Back .....	68
Back, Pain in..... 23, 26	26
Bacteria .....	83
Banti's Disease .....	10
Bartholin's Gland .....	78
Bartholinitis .....	17, 33
Basedow's Disease .....	10
Base, Fracture of..... 50, 51, 57, 61,	62
Base of Skull, Fracture of.....	48
Bearing Down, Sensation of.....	67
Bechterew's Disease .....	10
Belladonna, Action of.....	57
Belladonna Poison .....	80
Bell's Paralysis .....	10
Benign Tumors .....	10
Bile .....	68, 82
Ducts, 68; Pigment, 83; Secretions, 68, 82	
Biliary Congestion .....	37
Bilious Fever .....	10
Biliousness .....	10
Black Specks .....	58
Bladder .....	77
Calculus, 30; Cancer of, 30, 33, 34; Distended, 30, 40, 67;	
Hernia of, 10, 12; Muscle, 75; Neuralgia of, 30; Tubercle	
of, 30, 33, 34; Ulcer of, 30, 34, 47; Villous Growth in, 34	
Bleeding—	
Gums, 10, 11; Meatus, 48; Nose, 62	
Blepharitis, Marginal .....	54
Blocked Nerves .....	10, 76
Blood .....	68
Clot, 10; Count, 3, 68; Pressure, 7; Sugar, 10, 68; Vessels, 73	

	Page
Bloody Flux .....	10
Blow on Ear .....	47
Blow on Head .....	50
Boil .....	60
Boil, Meatus .....	49
Bone—	
Cancer of, 38; Diseased, 19; Marrow, 72; Tuberculous, 37, 38	
Bones .....	70-72
Botulism .....	10
Bowels—	
Cancer of, 31; Foreign Body in, 31; Perforation of, 30, 33	
Brachial Neuralgia .....	35
Brachial Neuritis .....	35
Brain .....	77
Abscess, 20; Anaemia, 50, 56, 57, 58, 59, 63; Atrophy of, 49, 59; Compression of 20, 57; Concussion of, 52, 56, 57; Dementia, 74; Embolism, 60; Fag, 74; Hyperaemia of, 20, 58, 59, 62, 64; Hypertrophy of, 20; Relaxed, 74; Sinus, 82; Softening of, 21, 60; Stimuli, 74; Toxins, 13; Tumor, 21, 50, 56, 58, 59, 60, 64	
Breast .....	77
Cancer of, 26; Neuralgia of, 26; Tenderness in, 45	
Brill's Disease .....	10
Broadcast .....	7
Bronchial Calculus .....	26
Bronchial Glands, Enlarged .....	26, 44, 62
Bronchial Irritation .....	10
Bronchial Tubes .....	77
Bronchitis .....	26, 28, 45, 61, 62
Broncho-pneumonia .....	11, 13
Bruises .....	11
Bulbar Paralysis .....	52, 68
Burn, Radium .....	13
Burns .....	11
Bursitis .....	11
Caecal Hernia .....	11, 12
Caecum .....	78
Cancer of, 46; Loaded, 31; Mobile, 31, 46; Tubercle of, 47;	
Caisson Disease .....	38, 39
Calcaneum .....	71
Calcium Oxalate .....	83
Calcium Phosphate .....	83
Calculus .....	31
Bladder, 30; Bronchial, 26; Pancreatic, 29, 32, 40, 41; Prostate, 33; Renal, 25, 31, 32, 34, 36, 37, 40, 41, 42, 43, 44, 46; Ureteral, 31, 32, 34, 40, 46; Urethral, 34, 40; Vesical, 25, 33, 34, 36, 40, 41, 43, 47	
Camphor Poisoning .....	80
Canal, Semi-circular .....	78
Cancer (See Carcinoma) .....	15, 61
Abdominal, 32; Bladder, 30, 33, 34; Bone, 38; Bowels, 31; Breast, 26; Caecum, 46; Colon, 27, 28, 30; Duodenum, 27, 41; Encephaloid, 55; Kidneys, 25; Labyrinth, 49; Liver, 23, 27, 29, 35, 45; Lung, 28; Medullary, 11; Melanotic, 11; Oesophagus, 40, 41; Omental, 30; Pancreas, 27, 29, 40; Pleura, 27; Prostate, 33, 34; Pylorus, 27, 29; Rectum, 24, 31, 33, 34, 36, 38, 41, 66, 67; Renal 44; Scirrhus, 11; Spine, 23, 25, 44; Spleen, 46; Stomach, 25, 26, 27, 28, 29, 41, 46, 65; Testicles, 24, 34; Throat, 23; Tongue, 19, 22; Toxins, 11, 13; Upper Jaw, 22; Uterus, 16, 17, 18, 24, 30, 31, 34, 38, 40, 46	
Candy Toxins .....	13
Canker Sore .....	11
Cantharides Poisoning .....	23, 80
Carbohydrate Poisoning .....	80
Carbohydrate Toxins .....	13
Carbon .....	75
Carcinoma (See Cancer) .....	43
Ear 48; Eye, 55; Nose, 62; Toxins, 13	

	Page
Cardiac Opening, Stomach.....	80
Cardiac Sac .....	72, 79
Caries	
Cervical, 22, 35, 57; Dental, 35; Dorsal Spine, 26; Ethmoid, 61; Lower Jaw, 22; Lumbar, 34; Lumbo-sacral, 36; Nasal, 62; Ribs, 27; Sicca, 44; Spine, 25, 26, 27, 29, 30, 32, 37, 41, 42, 43, 44; Sternum, 26, 43, 45; Teeth, 19; Temporal Bone, 22, 48, 52; Upper Jaw, 22; Vertebrae, 23	
Carotid Aneurysm .....	10, 11
Cartilage .....	76
Displaced, 39, 42; Ensiform, 76; Loose, 39; Rib, 76; Semi- lunar, 76	
Caruncle .....	17
Caruncle, Urethra .....	11, 14
Catalepsy .....	20, 50, 52, 56, 68
Cataract .....	56, 58
Cataract, Incipient .....	58
Catarrh .....	11
Cervical, 15, 17, 24; Chronic Nasal, 62; Duodenal, 20, 35, 37, 58; Gastric, 28; Middle Ear, 50; Naso-pharyngeal, 23	
Catarrhal Ulcers .....	53
Cauda Equina, Tumor of.....	25, 38
Caudate Lobe, Liver.....	79
Cellulitis, Pelvic.....	16, 36, 42, 46
Cerebellar Ataxy, Hereditary.....	20
Cerebellar Disease .....	23, 60
Cerebellar Tumor .....	26, 41
Cerebellum .....	77, 82
Haemorrhage into, 57; Lesion of, 49	
Cerebral Abscess .....	10
Cerebral Aneurysm .....	50
Cerebral Embolism .....	20
Cerebral Haemorrhage .....	57, 59, 60
Cerebral Hyperaemia .....	57
Cerebral Paralysis .....	12
Cerebral Thrombosis .....	21, 50, 51, 57, 59
Cerebral Tumor.....	19, 40, 43, 59
Cerebro-spinal Meningitis.....	19, 21, 23, 37, 44, 49, 52, 57, 59, 60
Cerebrum .....	77, 82
Cervical Caries .....	22, 35, 57
Cervical Catarrh .....	15, 17, 24
Cervical Glands .....	73
Cervical Pachymeningitis .....	36
Cervical Plexus .....	76
Cervical Rib .....	35, 41, 63, 64
Cervical Vertebrae .....	72
Cervicals .....	77
Cervicitis .....	67
Cervico-brachial Neuralgia .....	35
Cervico-dorsal Neuralgia .....	11
Cervico-occipital Neuralgia.....	19, 23, 43, 50
Cervix .....	79
Eroded, 17, 31, 46; Fibroid, 18; Granular, 17; Hypertrophied, 17, 67; Long Conical, 15	
Chalazion .....	52
Chancre .....	11
Chancroid .....	11
Cheerful .....	74
Chemicals, Poisoning from.....	80
Chest .....	72
Pain in, 26-29; Tenderness in, 45	
Chickenpox .....	11
Chickenpox Toxins .....	13
Chilblain .....	64
Chloasma .....	11
Chlorine Gas .....	73
Chlorophyl Poisoning .....	80
Chloroma .....	22, 55, 60, 62
Chlorosis.....	15, 16, 20, 47, 51, 54, 62, 64
Choking .....	11



	Page
Cholecystitis.....	27, 28, 29, 42, 43
Cholelithiasis.....	11
Cholera, Asiatic.....	29, 32, 37, 50, 58, 65
Chondroma.....	36
Chondroma, Ear.....	48
Chorea.....	25, 39, 52
Chyli.....	73
Chyluria.....	25, 30
Cigarette Poisoning.....	80
Circulation.....	72
Arteries, 72; Blood Vessels, 73; Defective, 63; Lymph Glands, 73; Veins, 73	
Cirrhosis, Kidney.....	19, 20, 58, 60, 62, 65
Cirrhosis, Liver.....	16, 82, 45, 62, 66
Cirrhosis, Stomach.....	26, 29, 46
Cirsoid Aneurysm.....	48, 63
Cisterna Chyli.....	73
Clavicle.....	71
Clitoris.....	79
Clot, Ureter.....	40
Cobalt.....	75
Cocaine.....	55
Action of 53, 57; Cocaine Poisoning, 80	
Coccygeal Pain.....	24
Coccyx.....	72
Injuries to, 24; Joints, 72	
Cold (See Coryza).....	47
Colic.....	31, 32, 40
Abdominal, 42; Appendicular, 31, 40; Gallstones, 40; He- patic, 35, 41, 44, 51; Lead, 33, 40; Renal, 23, 34, 43; Tubal 17, 30, 40	
Colitis.....	15, 28, 31, 32, 35, 40
Colitis, Membranous.....	34
Collapse.....	11
Colloidal Tissue.....	73
Colon.....	77
Cancer of, 27, 28, 30; Growth on, 36; Transverse, Disten- sion of, 29; Tumor of, 34	
Color Blindness.....	58
Color Index, Blood Count.....	68
Coma.....	54
Alcoholic, 56; Diabetic, 56	
Commissures, Palpebral.....	78
Compression, Brain.....	20, 57
Compression, Cord.....	23, 38, 39, 41, 44
Concretions.....	24, 32, 40
Intestinal, 32; Tonsils, 23	
Concussion, Brain.....	52, 56, 57
Condylomata.....	33, 34
Congenital Defect, Eye.....	58
Congenital Defeat, Meatus.....	49
Congestion—	
Biliary, 37; Hepatic, 35; Liver, 20; Uterus, 15, 16, 47, 67	
Congestive Headache.....	66
Conium Poisoning.....	23, 81
Conjunctiva.....	54-56, 78
Foreign Body in, 54; Pallid, 54; Protruding, 55; Watery, 54	
Conjunctivitis.....	21, 55, 58
Conjunctivitis, Parinaud's.....	54
Constipation.....	19, 20
Constricted Liver.....	28
Contraction—	
Fascia, 11; Pupils of Eye, 57; Scars, 53	
Contracture.....	11
Contusions.....	11
Copper.....	75
Cord—	
Compression of, 23, 38, 39, 41, 44; Hyperaemia of, 23, 63. Lesion of, 57; Spermatic, 79; Spinal, 77, 78, 82; Tumors of, 24, 26, 30, 66	

	Page
Corn .....	37
Corn, Inflamed .....	31
Cornea .....	53-54, 78
Congenital Syphilis of, 53; Hazy, 53; Hepatic Ulcer of, 53;	
Phlyctenular Ulcer of, 53; Rodent Ulcer of, 53; Trachoma-	
tous Ulcer of, 54; Tuberculosis of, 53; Tuberculous Ulcer	
of, 54; Ulcer of, 53-54, 59	
Corneal Reflex Abolished .....	54
Coronary Arteries .....	72
Corpora Quadrigemina, Lesion of .....	49
Corpus Luteum .....	79
Corrosive Poisoning .....	23, 80
Cortex .....	77
Coryza (See Cold) .....	20, 21, 37, 49, 54, 60, 61
Costal Periostitis .....	45
Costal Sterni joints .....	72
Costal Vertebrae .....	72
Cough .....	11
Cramp .....	11
Cranial Nerves .....	5, 76
Cranial Nerves, Function of .....	76, 77
Cranial Tumor .....	42
Cranium .....	71
Crico-arytenoid Arthritis .....	23
Crus, Tumor of .....	52
Crystals, Poisoning from .....	80
Cuneiform .....	71
Curvature, Lateral .....	25
Cyanotic Liver .....	28, 29, 45
Cyst .....	34
Dermatoid, 11; Dermoid, Ear, 48; Eyelid, 51; Mesenteric, 33;	
Middle Turbinate, 61; Multiple, 26; Orbit, 55; Ovarian, 15,	
32, 33, 36, 40, 65, 67; Sebaceous, 30; Sebaceous, of Ear, 48;	
Sebaceous, Suppurating, 49; Testicular, 31	
Cystitis .....	17, 25, 30, 33, 34, 47
Cystocele .....	33
Dacryocystitis .....	51, 52, 54
Dandruff .....	11
Deafness .....	49
Death .....	73
Death of Foetus .....	18
Delirium Tremens .....	50
Dementia .....	47, 74
Dementia, Acute Primary .....	56
Dementia Praecox .....	74
Dental Caries .....	35
Dental Exostosis .....	22
Dental Pulpitis .....	22, 40
Depressed .....	74
Dermatitis .....	64
Dermatoid Cyst .....	11
Dermoid Cyst, Ear .....	48
Despondent .....	74
Destroyed Toxins .....	13
Deviate Septum .....	55
Diabetes Insipidus .....	15, 18, 19, 20, 40
Diabetes Mellitus .....	15, 18, 19, 20, 38, 53, 54, 64
Diabetes, Phosphatic .....	25
Diabetic Coma .....	56
Diacetic Acid .....	68, 83
Diaphragm .....	73
Diaphragmatic Hernia .....	32, 43
Diaphragmatic Neuralgia .....	28, 45
Diaphragmatic Pleurisy .....	20, 33, 35, 43, 45, 46
Diarrhoea .....	31, 32
Diarrhoea, Acid .....	10, 11
Diarrhoea, Amoeba Dysenterica .....	11, 31
Digestive Trouble .....	51
Dilatation .....	11
Heart, 65, 66; Stomach, 20, 29, 65, 66, 67	

	Page
Dilated Ethmoid Cells.....	55
Dilated Right Ventricle.....	29, 46, 65
Dilation, Pupils of Eye.....	56-57
Diphtheria.....	18, 23, 48, 49, 61, 62
Meatus, 48; Nasal, 61; Toxins, 13	
Diphtherial Ulcer, Eye.....	53
Diphtheritic Discharge, Eye.....	55
Diphtheritic Paralysis.....	52, 56, 57, 59
Diplopia, Monocular.....	58
Diplopia, Strabismus.....	11, 57-58
Discharge.....	17-18
Diphtheritic, Eye, 55; Gonorrhoeal, Eye, 55; Offensive, 18;	
Purulent, 61; Purulent, Conjunctiva, 55; Sanguino-purulent,	
17-18; Simple, Eye, 55; Tuberculous, Eye, 55; Vaginal, 17-	
18; White, 17	
Discomfort.....	74
Diseases and Their Causes.....	15-68
Diseases, General.....	10-14
Dislocation.....	11
Dislocation, Lens.....	56, 58
Displacement—	
Cartilage, 39, 42; Heart, 65, 66; Ovaries, 16; Punctum, 54;	
Uterus, 36	
Disseminated Sclerosis.....	20, 40, 58, 63, 64, 65
Disseminated Sclerosis, Spine.....	23
Distemper.....	11
Distension—	
Antrum, 61; Bladder, 30, 40, 67; Frontal Sinus, 51, 55;	
Transverse Colon, 29; Transverse Nasal Vein, 60	
Divarication, Recti.....	30
Diverticula, Oesophagus.....	11
Diverticulitis.....	31
Diverticulitis, Meckel's.....	31
Dorsal Vertebrae.....	72
Dropsy.....	11
Drug Poisoning.....	80
Drug Rashes.....	64
Ducts—	
Milk, 73; Nasal, 77; Thoracic, 73; Bile, 68; Lacrimal, 78	
Ductus Deferens.....	79
Duodenal Catarrh.....	20, 35, 37, 58
Duodenum.....	79
Cancer of, 27, 41; Secretin, 82; Ulcer of, 28, 30, 35, 41,	
42, 44, 65	
Dura Mater, Haematoma of.....	19, 20, 57
Dysentery.....	31, 34, 40, 62
Dysmenorrhoea—	
15-16, 19, 20, 24, 25, 30, 31, 36, 40, 43, 46, 47, 67	
Dysmenorrhoea, Membranous.....	18
Dyspareunia.....	17
Dyspepsia.....	28, 32, 60, 66, 67
Dyspepsia, Atonic.....	35
Dyspepsia, Flatulent.....	65
Dyspnoea.....	20, 47, 55, 56
Ear.....	47-49, 78
Abscess of, 47; Abscess bursting into, 48; Ache, 21; An-	
geioma of, 48; Blows on, 47; Carcinoma of, 48; Chondroma	
of, 48; Dermoid Cyst of, 48; Epithelioma of, 48; External,	
78; Frost bite of, 47, 48; Gangrenous, 48; Growths on, 48;	
Gummata of, 48; Injuries to, 22; Irritation in, 60; Livid, 47;	
Malformation of, 47; Middle, 78; Polypus of, 22, 48; Ray-	
naud's Disease of, 48; Rodent Ulcer of, 48; Ruptured or	
Perforated Membrane, 49; Sarcoma of, 48; Sebaceous Cyst	
of, 48; Swollen, 47-48; Trauma of, 48; Wax, 11, 78	
Ears, Waxy.....	47
Echymosed Eyelids.....	51
Ecstatic.....	74
Ectopic Gestation.....	15, 16, 18, 26, 32, 39
Eczema.....	53, 64
Crusts, 51; Meatus, 22, 48	

	Page
Forgetfulness .....	74
Foreign Body .....	32, 50
Bowels, 31; Conjunctiva, 54; Lungs, 26; Meatus, 22, 48;	
Nose, 22, 61, 62; Rectum, 34; Throat, 23	
Formication .....	63
Fracture .....	39, 42
Base, 50, 51, 57, 61, 62; Base of Skull, 48; Jaw, Lower, 22;	
Orbital Plate, 55; Rib, 27, 42, 43; Spine, 27; Tibia, 31	
Frontal Bone .....	71
Frontal Empyema .....	22
Frontal Headache .....	18-19
Frontal Sinus .....	82
Frontal Sinus Distension .....	51, 55
Frontal Sinus Empyema .....	61
Frontal Sinus Obstruction .....	18
Frost Bite, Ear .....	47, 48
Fullness, Sensation of .....	66
Functional Heart Disorder .....	27
Furuncle, Meatus .....	22, 48
Gall-bladder .....	79
Gall-bladder, Empyema of .....	28, 45
Gallstone Colic .....	40
Gallstones .....	13, 28, 29, 30, 31, 32, 45, 46
Gangrene .....	11
Gangrenous Ear .....	48
Gangrenous Tip of Nose .....	60
Garet's Sign .....	59
Gas .....	73
Gas, Emission of .....	18
Gas Poisoning .....	81
Gasserion Ganglion .....	77
Gastralgia .....	27, 29, 32, 42, 65
Gastric Abscess .....	10
Gastric Catarrh .....	28
Gastric Influenza .....	32
Gastric Irritation .....	26, 29, 66, 67
Gastric Secretin .....	82
Gastric Ulcer .....	26, 30
Gastritis .....	19, 26, 27, 29, 41, 44, 46, 59, 65, 66, 67
Gastro-cholecystic Adhesions .....	29
Gastro-intestinal Adhesions .....	29
Gastroptosis .....	28
General Diseases .....	10-14
General Paralysis .....	20, 38, 47, 56, 57, 67
Gestation, Ectopic .....	15, 16, 18, 26, 32, 39
Gestation, Tubular .....	47
Girdle Sensation .....	65
Gland, Bartholin's .....	78
Gland, Lachrymal, Enlarged .....	55
Glanders .....	23, 38, 39, 61
Glanders, Lid .....	51
Glands .....	73
Bronchial Enlarged, 26, 44, 62; Endocrine, 8-9, 73; In-	
flamed, 32; Lymph, 9, 73; Mastoid Inflamed, 22; Sacral,	
Enlarged, 36	
Glandular .....	74
Glandular Fever .....	20, 22, 32, 42
Glass .....	74
Glaucoma .....	19, 20, 21, 51, 53, 55, 56
Glossopharyngeal Nerve .....	76
Glycerine Poisoning .....	81
Glycogen .....	82
Goitre, Exophthalmic—	
15, 16, 20, 51, 52, 53, 54, 55, 62, 65, 66, 67	
Gold .....	75
Gonorrhoea .....	17, 61
Gonorrhoeal Arthritis .....	37, 39, 42, 43
Gonorrhoeal Discharge, Eye .....	55
Gonorrhoeal Endometritis .....	30
Gonorrhoeal Ulcer, Eye .....	53

Luschka's  
Gland 727  
(treat for Asthma)

	Page
Gout.....	15, 18, 19, 20, 27, 36, 37, 39, 41, 42, 47, 50, 60, 64
Gout, Stomach.....	29
Graefe's Symptom.....	53
Granular Cervix.....	17
Granular Os.....	16
Granulation, Meatus.....	48
Granulations, Urethra.....	34
Granuloma Coccidioides.....	11
Gravel.....	25, 34
Grief.....	74
Groin, Pain in.....	31
Growing Pains.....	18
Growth, Colon.....	36
Growth Fever.....	39
Growths—	
Bladder, 34; Ear, 48; Intra-nasal, 55; Mediastinal, 41, 65;	
Ovarian, 16; Pharynx, 61	
Gumma.....	35, 43
Gumma, Orbit.....	55
Gummata.....	52
Ear, 48; Nose, 61	
Gums.....	74
Bleeding, 10, 11; Receding, 11, 13; Septic, 39	
Haematocele.....	16, 35
Haematocele, Pelvic.....	30
Haematoma.....	47
Dura Mater, 19, 20, 57; Septum, 61	
Haemoglobin.....	68
Haemophilia.....	16, 38, 51, 62
Haemorrhage.....	20, 58, 59
Abdominal, 10; Arrest, 11; Cerebellum, 57; Cerebral, 57,	
59, 60; Intra-cranial, 49; Meningeal Spinal, 23, 24, 39,	
41, 64; Pons, 57; Retrobulbar, 56	
Haemorrhoids—	
External, 17, 24, 31, 33, 34, 64, 67; Inflamed, 47; Internal,	
17, 24, 31, 33, 34, 64, 67	
Hair.....	74
Hand.....	74
Bones of, 71; Pain in, 36; Trauma of, 36; Tubercle of, 36	
Hate.....	74
Hate Toxins.....	13
Hay Fever.....	20, 49, 51, 54, 60, 61
Head.....	74
Blow on, 50; Bones of, 71; Top of, 74	
Headache—	
Congestive, 66; Frontal, 18-19; Migraine, 19, 21, 43, 50,	
57, 59, 60, 66; Occipital, 19; Unilateral, 19-20; Unclassi-	
fied, 20-21	
Hearing.....	49-50, 78
Hearing Centers.....	78
Heart.....	79
Aneurysm of, 27; Burn, 27, 65; Dilatation of, 65, 66; Disease,	
16, 43, 44; Disorder, Functional, 27; Displacement of, 65,	
66; Fatty, 53, 65, 66; Fibroid, 27, 65; Hypertrophy of, 20,	
50, 55, 58, 62, 64, 66; Malformation of, 47, 65; Strain,	
27, 45; Syphilitic, 27, 40, 65	
Heat, Sensation of, Local.....	66
Heel Jar.....	37
Heel, Pain in.....	37
Hemiatrophy, Facial.....	52
Hemiplegia.....	54
Henna Poisoning.....	81
Henoch's Purpura.....	31, 32, 40
Hepatic Abscess.....	27, 35, 45
Hepatic Aneurysm.....	40
Hepatic Colic.....	35, 41, 44, 51
Hepatic Congestion.....	35
Hepatic Enlargement.....	66
Hepatic Flexure.....	77
Hepatic Secretions.....	82

Treat  
 (6)49420  
 Portal Vein

	Page
Hepatic Vein .....	73
Hepatitis, Acute .....	28, 35, 45
Hepatoptosis .....	29
Hereditary Cerebellar Ataxy .....	20
Hernia .....	31, 32, 35, 40
Abdominal, 10, 12, 30; Bladder, 10, 12; Caecal, 11, 12;	
Diaphragmatic, 32, 43; Femoral, 12; Inguinal, 12, 31; Ob-	
turator Ventral, 31, 36, 42; Small Epigastric, 29; Stran-	
gulated, 12, 32; Umbilical, 31; Ventral, 12, 25	
Herpes .....	43
Auris, 22, 48, 50; Frontalis, 54; Zoster, 27, 28, 32, 45	
Herpetic Ulcer, Eye .....	53
Hiccough .....	12
Hip—	
Bones of, 71; Disease, 24, 36, 39, 41; Joints, 72	
Host to Syphilis .....	12
Hormone Glands .....	73
Hormone Secretions .....	82
Hot Flashes .....	12-
Howship-Romberg Sign .....	36
Humerus .....	71
Hydatids .....	25
Inflamed, 28, 45; Kidney, 40; Orbit, 55	
Hydrocele .....	35
Hydrocele, Encysted .....	35
Hydrocephalus .....	20, 43, 49, 55, 56, 59, 60
Hydrochloric Acid .....	68, 82
Hydrogen .....	73
Hydronephrosis .....	25, 32
Hymeneal Orifice, Inflamed .....	17
Hyoid .....	71
Hyperaemia .....	71
Brain, 20, 58, 59, 62, 64; Cerebral, 57; Cord, 23, 63;	
Spine, 23, 63, 64	
Hyperchlorhydria .....	29, 42
Hypermetropia .....	57
Hypersensitive .....	74
Hypertrophic Endometritis .....	67
Hypertrophy .....	12
Brain, 20; Cervix, 17, 67; Heart, 20, 50, 55, 58, 62, 64, 66;	
Uterus, 15, 16, 30	
Hypochondrium, Pain in .....	27-28
Hypochondrium, Tenderness in .....	45-46
Hypochondriasis .....	46, 58, 64
Hypogastric Plexus .....	76
Hypogastrium, Pain in .....	30
Hypogastrium, Tenderness in .....	47
Hypoglossal Nerve .....	76
Hysteria .....	15, 19, 20, 24, 26, 27, 32, 36, 38, 41, 44, 45, 46,
49, 50, 52, 54, 56, 58, 59, 60, 63, 64, 65, 66, 67, 75	
Hysterical Oedema .....	63
Ichthyosis .....	12
Ileo-caecal Valve .....	77
Ileum .....	79
Ileus .....	32
Iliac Pain .....	31
Iliac Tenderness .....	46-47
Ilio-sacral Joints .....	72
Ilium .....	71
Impacted Faeces .....	34, 36, 46
Impinged Nerves .....	5, 12, 76
Incisors .....	82
Incus .....	78
Indican .....	83
Indigestion .....	50, 65
Induration, Lobular .....	26
Infantile Paralysis .....	25, 37, 39
Infantile Scurvy .....	18, 36, 51, 55, 62
Infarct, Renal .....	44
Infarct, Spleen .....	28, 46

	Page
Inflammation—	
Glands, 32; Haemorrhoids, 47; Hydatids, 28, 45; Hymeneal Orifice, 17; Local, 66; Mastoid, 22; Mucous Membrane, 93; Pancreas, 33, 46; Serous Membrane, 39; Synovial Membrane, 39; Tophi, 48; Visceral, 37; Visceral Parenchyma, 39	
Influenza	18, 20, 25, 26, 38, 45, 46, 54, 61, 62, 66
Gastric Form, 32; Intestinal, 32, 37; Toxins, 13	
Inguinal Hernia	12, 31
Injuries	39, 51
Coccygeal, 24; Ear, 22; Eye, 51; Nose, 60; Testicle, 35	
Innominate Aneurysm	21, 23, 35, 40, 56
Innominate, Sarcoma of	36
Insanity	58, 75
Insomnia	12, 75
Intercostal Muscle	76
Intercostal Neuralgia	27, 28, 29, 45
Intercostal Rheumatism	27, 43, 45
Interscapular Pain	26
Intestines—	
Concretion of, 32; Fibrositis of, 37; Influenza, 32, 37; Irritation of, 53; Neuralgia of, 32; Obstruction of, 32; Rheumatism of, 32; Secretions of, 82; Ulcer of, 33	
Intra-cerebellar Pressure	12, 13
Intra-cerebral Pressure	12, 13
Intra-cranial Haemorrhage	49
Intra-cranial Tumor	42
Intra-ocular Pressure	12, 13
Intra-nasal Growth	55
Intussusception	32, 40
Inversion, Uterus	16, 24, 30, 67
Involuntary Muscle	76
Iodide Poisoning	81
Iodine	75
Iodism	51, 54, 60, 61
Iris	78
Iritis	19, 20, 21, 57, 59
Iron	75
Irritant Poisoning	23, 29, 32, 46, 66, 81
Irritants, Eye	54
Irritation—	
Bronchial, 10; Ear, 60; Gastric, 26, 29, 66, 67; Intestinal, 53	
Ischio-rectal Abscess	33, 34, 37
Ischium	71
Itching	12, 63
Jaundice	21, 45, 54, 62, 64
Jaw—	
Lower, Caries of, 22; Lower, Fracture of, 22; Lower, Pain in, 22; Upper, Cancer of, 22; Upper, Caries of, 22; Upper, Pain in, 22	
Jealousy	75
Jejunum	79
Jejunum, Secretin	82
Joints	72
Pain in, 39; Tuberculous, 39, 42, 43	
Jugular Vein	73
Kali-azar, Infantile	12
Keratitis	21, 53, 59
Kidneys	79
Cancer of, 25; Cirrhosis of, 19, 20, 58, 60, 62, 65; Floating, 25, 28, 38, 40; Hydatids of, 40; Interstitial Tissue, 79; Large White, 12; Movable, 28, 37; Small White, 12; Tuberculous, 15, 25, 32	
Klumpke's Paralysis	57
Knee, Bones of	71
Knee Joints	72
Kocher's Symptom	53
Labia Majora	79
Labia Minora	79
Labial Oedema	17
Laceration Perinaeal	17

	Page
Labyrinth—	
Cancer of, 49; Disease of, 50; Fistula of, 50; Syphilis of, 50; Tumor of, 49	
Lachrymal Ducts (See Lacrimal Ducts)	
Lachrymal Gland, Enlarged.....	55
Lachrymal Sac (See Lacrimal Sac)	
Lacrimal Ducts .....	78
Lacrimal Sac .....	78
Lacteal Duct, Obstruction of.....	26
Lacteal Glands .....	73
Lactate Poisoning .....	81
Lactic Acid .....	68
Lactose Poisoning .....	81
Lacus Lacrimalis .....	78
Landouzy Dejerine Paralysis .....	53, 54
Large Mononuclears .....	70
Laryngitis .....	23
Larynx .....	80
Larynx,, Ulcer of.....	22
Lateral Sinus, Thrombosis of.....	44, 49
Laziness, Mental .....	75
Lead .....	75
Colic, 33, 40; Poisoning, 15, 16, 18, 21, 32, 37, 38, 39, 49, 60	
Leg .....	74
Bones of, 71; Pain in, 37; Numbness of, 12	
Lens .....	78
Lens, Dislocation of .....	56, 58
Leprosy .....	53, 63
Lesion—	
Cerebellum, 49; Cord, 57; Corpora Quadrigemina, 49; Medulla, 49; Pons, 49; Tongue, Basal, 19; Toxins of, 13	
Leukaemia .....	15, 16, 33, 37, 47, 49, 50, 62
Leukaemia, Lymphatic .....	55
Leukaemia, Spleno-medullary .....	46
Leukocytes .....	69, 83
Leukorrhoea .....	17, 21, 51, 64
Leydig Cells .....	79
Lie (Falsehood) .....	12
Ligamentous System .....	76
Ligaments .....	76
Limbs, Pain in.....	35-38
Lime .....	75
Lipoma .....	12
Lithaemia .....	18, 19, 21, 25, 37, 41, 50, 65, 67
Liver .....	79
Abscess of, 29, 45; Affections, 41, 43; Cancer of, 23, 27, 29, 35, 45; Caudate Lobe of, 79; Cirrhosis of, 16, 28, 45, 62, 66; Congestion of, 20; Constricted, 28; Cyanotic, 28, 29, 45; Disease, 44; Disorders, 58; Fatty Degeneration of, 45; Falciform Ligament of, 79; Pain Over, 27-28; Tenderness, 46; Sarcoma of, 45; Syphilis of, 28, 45, 67	
Livid Ear .....	47
Lobular Induration .....	26
Local Abscess .....	42
Localization .....	6
Localized Swellings .....	52
Locomotor Ataxy .....	18, 19, 25, 26, 29, 32, 33, 36, 37, 38, 39, 40, 41, 43, 49, 52, 55, 57, 58, 59, 60, 63, 64, 65, 66
Loose Cartilage .....	39
Lues, Congenital, Toxins of.....	13
Lumbago .....	25, 42
Lumbar Abscess .....	25, 36, 44
Lumbar Caries .....	34
Lumbar Pain .....	25-26
Lumbar Tenderness .....	44
Lumbar Vertebrae .....	72
Lumbo-adorinal Neuralgia .....	25, 33
Lumbo-sacral Caries .....	36
Lungs .....	79
Cancer of, 28; Emphysema of, 28, 62, 66, 67; Foreign Body in, 26	



	Page
Lupus .....	55, 60, 62
Lupus Erythematosus .....	43
Lymphadenoma .....	15, 23, 33, 55, 64
Lymph Glands .....	9, 73
Lymph Nodes .....	73
Lymphatic Leukaemia .....	55
Lymphocytes .....	69
Lysol Poisoning .....	81
Macroblasts .....	69
Macropia .....	59
Magnesium .....	75
Magnesium Poisoning .....	81
Malar .....	71
Malaria .....	16, 18, 28, 45, 46, 50, 66
Malaria Toxins .....	13
Male Organs .....	79
Male Sex .....	82
Malformation .....	47, 74
Ears, 47; Heart, 47, 65	
Malignancy .....	12
Malignant Disease of Nose .....	61
Malingering .....	75
Maleus .....	78
Malposition .....	74
Mama, Pain in .....	26
Mammary Abscess .....	26, 45
Mammary Glands, Neuralgia of .....	26
Mammillaries .....	73
Mammillary Secretions .....	82
Mandible .....	71
Mandible Joints .....	72
Manganese .....	75
Mania .....	33, 47, 50, 57
Mast Cells .....	70
Mastitis, Chronic .....	26, 45
Mastoid—	
Abscess, 19, 21, 43; Bone, 71; Disease, 50; Sinus, 82	
Mastoiditis .....	22, 48
Maxillary, Inferior, Neuralgia of .....	22
Maxillary, Superior .....	71
Maxillary, Superior, Neuralgia of .....	22
Measles .....	21, 49, 54, 59, 60, 61, 62
German, 21, 51; German, Toxins of, 13; Malignant, 51;	
Toxins of, 13	
Meatus—	
Bleeding, 48; Boil in, 49; Congenital Defect of, 49; Diptheria of, 48; Eczema of, 22, 48; Epithelioma of, 48; Erosion of, 48; Exostosis of, 48; Foreign Body in, 22, 48; Furuncle in, 22, 48; Granulations in, 48; Swelling in, 48; Trauma of, 49; Tuberculosis of, 49; Wax in, 19, 49, 50	
Meckel's Diverticulitis .....	31
Median Nerve .....	76
Mediastinal Abscess .....	26, 28, 44
Mediastinal Disease .....	45
Mediastinal Growth .....	41, 65
Mediastinal Tumor .....	26, 29, 35, 44, 67
Mediastinitis .....	51
Medulla .....	77
Lesion of, 49; Secretions, 82;	
Medullary Cancer .....	11
Melancholia .....	15, 47, 54, 56, 65, 75
Melanotic Cancer .....	11
Membranes .....	74
Mucous, Inflammation of, 39; Perforated or Ruptured, Ear, 49; Serous, Inflammation of, 39; Synovial, Inflammation of, 39	
Membranous Colitis .....	34
Membranous Dysmenorrhoea .....	18
Meniere's Disease .....	49, 50
Menigeal, Spinal, Haemorrhage .....	23, 24, 39, 41, 64

	Page
Meninges .....	77
Meningitis .....	18, 21, 33, 36, 37, 38, 40, 41, 42, 43, 44, 49, 50, 53, 54, 56, 57, 59, 60, 64
Cerebro-spinal, 19, 21, 23, 37, 44, 49, 52, 57, 59, 60; In-	
ternal Spinal, 24, 25, 41; Spinal, Syphilitic, 66; Tuberculous,	
24, 25, 38, 52, 56, 57	
Meningocele .....	55
Meningococcus .....	12
Menopause .....	16, 21, 62, 64, 65, 66, 74
Menorrhagia .....	16-17, 52
Menses, Suppression of .....	60
Menstruation .....	15-17, 26, 45, 52, 74
Delayed, 12, 74; Function of, 74	
Mental Fatigue .....	11, 74
Mental Laziness .....	75
Mental Overstrain .....	21
Mental Rates .....	74-75
Mercurialism .....	15, 40, 59
Mercurius Dulcis Poisoning .....	81
Mesenteric Cysts .....	33
Mesenteric Thrombosis .....	33
Mesentery .....	74
Metatarsus .....	71
Metritis .....	15, 16, 17, 18, 24, 30, 36, 47, 67
Metrorrhagia .....	16-17
Microblasts (Poikilocytes) .....	69
Micropia .....	59
Middle Ear .....	78
Catarrh, 50; Suppuration, 49	
Migraine .....	19, 21, 43, 50, 57, 59, 60, 66
Milk Duct .....	73
Minerals .....	75
Mineral Salts .....	75
Miscarriage .....	16, 18, 25
Mitral Stenosis .....	57, 62
Mitral Valve .....	79
Molars .....	82
Mollities Ossium .....	24, 28, 30, 38
Mononuclears, Large .....	70
Morphine Poisoning .....	81
Morphinism .....	15, 21, 57
Motor Nerves .....	76
Motor Nervous System .....	77
Mouth .....	75
Mouth Muscle .....	75
Movable Kidney .....	28, 37
Mucous Membranes .....	74
Mucous Membranes, Inflammation of .....	39
Mucous Threads .....	83
Multiple Neuritis .....	67
Multiple Sclerosis, Dorsal region of Meninges .....	12
Multiple Sclerosis, Lumbo-sacral region .....	12
Mumps .....	22, 49, 50
Mumps, Toxins of .....	13
Muscle .....	76
Intercostal, 76; Involuntary, 76; Pain in, 37-38; Rupture	
of, 38, 42; Sphincter, 75; Sprained, 23; Voluntary, 76	
Muscular Atrophy, Progressive .....	35, 36, 38
Muscular Rheumatism .....	16, 18, 19, 21, 23, 24, 26, 29, 33, 35, 36, 37, 38, 39, 41, 42, 43, 44
Muscular Structures .....	76
Muscular System .....	76
Myalgia .....	28, 33, 38
Myasthenia Gravis .....	52, 58
Myelitis .....	24, 38, 39, 44, 56, 63, 64
Myelitis, Transverse .....	66
Myelocytes .....	70
Myelocytes (Cornil's) .....	70
Myelocytes (Ehrlich's) .....	70
Myelosarcoma .....	38, 39
Myocarditis, Acute .....	27, 45, 65

	Page
Myopia	55, 56
Myopic	76
Myositis	38, 42
Nails	76
Nasal Bones	71
Nasal Caries	62
Nasal Catarrh, Chronic	62
Nasal Diphtheria	61
Nasal Duct	77
Nasal Vein, Transverse, Distension of	60
Naso-pharyngeal Catarrh	23
Naso-pharyngeal Disease	19
Nausea	56
Navicular	71
Neck	76
Abscess of, 22; Pain in, 22; Nape of, Pain in, 23; Tumor of, 56, 57, 63	
Necrosis	62
Necrosis, Temporal Bone	48
Nephralgia	25
Nephritis	15, 16, 18, 19, 21, 25 44, 49, 50, 54, 55, 58, 62, 64
Nephritis, Suppurating	25, 44
Nerve—	
Optic, Tumor of, 56; Third, Paralysis of, 52, 55, 56; Trunk, Pressure on, 63, 64	
Nerves	76
Afferent, 76; Blocked, 10, 76; Cervical, 5; Coccygeal, 5; Cranial, 5, 76; Dorsal, 5; Efferent, 76; Gasserion Ganglion, 77; Impinged, 12, 76; Lumbo-sacral, 5; Median, 76; Motor, 76; Optic, 78; Phrenic, 77; Radial, 76; Rheumatism of, 15; Sacral, 5; Sensory, 76; Sympathetic, 76; Sympathetic, Stimulation of, 53; Ulnar, 76	
Nervous System	77
Neucleic Acid Poisoning	81
Neuralgia	15, 21, 24, 34, 35, 39, 40, 41, 63
Bladder, 30; Brachial, 35; Breast, 36; Cervico-brachial, 35; Cervico-dorsal, 11; Cervico-occipital, 19, 23, 43, 50; Diaphragm, 28, 45; Fifth Nerve, 21; Intercostal, 27, 28, 29, 45; Intestinal, 32; Lumbo-abdominal, 25, 33; Mammary Glands, 26; Maxillary, Inferior, 22; Maxillary, Superior, 22; Rectal, 34; Trigeminal, 19, 21, 22, 44, 52, 54, 59, 61; Twelfth Dorsal Nerve, 31, 46; Uterus, 30;	
Neurasthenia	19, 20, 21, 23, 24, 25, 31, 33, 36, 37, 38, 43, 44, 50, 52, 56, 58, 59, 63, 65, 66, 67
Neurasthenia, Traumatic	35, 44, 64
Neuritis	35, 36, 39, 42, 43, 63, 64
Auditory, 49; Brachial, 35; Multiple, 67; Optic, 58; Pudic, 17	
Neurofibromata	29
Neuroma	35, 36, 63
Nictitation	52
Night-blindness	58
Nipple	80
Nipple, Cracked	26
Nitrogen	73
Nodes—	
Axillary, 73; Lymph, 73; Syphilitic, 19	
Nodules, Epididymis	35
Normoblasts	69
Nose	60, 80
Angioma of, 62; Bleeding, 52; Carcinoma of, 62; Fibroma of, 62; Foreign Body in, 22, 61, 62; Gangrenous Tip, 60; Gummata of, 61; Injury to, 60; Malignant Disease of, 61; Pain in, 22; Polypus of, 19, 21, 49, 50, 60, 61; Red, 60; Sarcoma of, 63; Swollen, 60; Syphilis of, 60, 61; Tubercle of, 61, 63; Ulcer of, 62, 63; Varicosities of, 63	
Nostrils	61
Nostrils Obstructed	61

Pellagra—	
Intestinal, 12; Mental (Brain), 12; Skin, 12	
Pelvic Abscess	18, 30, 41, 42
Pelvic Adhesions	15
Pelvic Cellulitis	16, 36, 42, 46
Pelvic Haematocele	30
Pelvic Peritonitis	16, 17, 24, 30, 46, 47
Pelvic Phleboliths	30
Pelvic Plexus	76
Pelvic Tumors	36, 67
Pelvis	72
Pelvis, Pain in	30
Penis	79
Penis, Pain in	34
Perforation	13
Bowel, 30, 33; Membrane, Ear, 49; Stomach, 43	
Periarteritis Nodosa	18, 28, 33, 38
Pericarditis	27, 29, 33, 45, 46, 65
Pericardial Effusion	67
Pericardium	79
Adherent, 65; Aneurysm of, 27; Pain in, 27	
Perichondritis, Acute	22, 48
Pericystitis	30, 47
Perihepatitis	28, 29, 43, 45
Perimetritis (See Parametritis)	15, 34, 36, 47
Perinaeal Abscess	25, 33
Perinaeal Laceration	17
Perinaeal, Testicle	33
Perinaeum	80
Pain in, 33-34; Tender, 47	
Perinephric Abscess	27, 28, 44
Perinephritis	25, 42, 43, 44
Periodontitis	22
Periomentum Secretions	82
Periosteum	72
Periostitis	19, 21, 37, 38, 41, 43
Costal, 45; Femoral, 36; Orbit, 55; Spinal, 44; Sternal, 45;	
Syphilitic, 29, 44	
Periproctitis	24, 67
Perisplenitis	46
Peritoneal Abscess	30
Peritoneal Adhesions	32, 38
Peritoneum	80
Peritonitis	28, 32, 42, 43, 46, 62, 66
Peritonitis, Pelvic	16, 17, 24, 30, 46, 47
Pernicious Anaemia	33, 49, 62, 65
Peroxide Poisoning	81
Pertussis	13
Pertussis, Toxins of	13
Peyer's Patches	79
Phalange Joints	72
Pharyngitis	17, 23, 49
Pharyngitis, Tubercular	23
Pharynx	80
Growth in, 61; Ulcerated, 22	
Phosphate Poisoning	81
Phosphorus Poisoning	16, 62, 81
Photophobia	59
Phlebitis	37
Phleboliths, Pelvic	30
Phrenic Nerve	77
Phthisis	15, 29, 38, 39, 45, 52, 54
Phosphorus	75
Phosphorus Poisoning	16, 21, 81
Phlyctenular Ulcer, Eye	53
Pineal	8, 73
Pisiform	71
Pituitary—	
Anterior, 8, 73; Pars Intermedia, 80; Posterior, 8, 73.	

	Page
Ovarian Growths .....	16
Ovarian Pain .....	31
Ovaries .....	9, 73, 79
Displaced, 16; Prolapsed, 17, 31; Small Cystic, 16	
Ovum .....	79
Oxaluria .....	21
Oxygen .....	73
Pachymeningitis .....	21, 23, 25, 36, 41, 42, 48
Pain .....	18-43
Acute, 56; Abdomen, 29-35; Abdominal, Unclassified, 32-33;	
Arm, 35-36; Back, 23-26; Character of, 39-43; Chest, 26-	
29; Chest, Unclassified, 28-29; Coccygeal, 24; Dull, 39; Epi-	
gastrium, 29-30; Eyeballs, 21; Foot, 37; General, 18; Groin,	
31; Hand, 36; Heel, 37; Hypochondrium, Left, 28; Hypo-	
chondrium, Right, 27-28; Hypogastrium, 30; Iliac, 31; In-	
creased at Night, 43; Increased by Breathing or Coughing,	
43; Increased by Movement, 42-43; Interscapular, 26;	
Lower, 22; Jaw, Upper, 22; Joints, 39; Leg, 37; Limbs, 35-	
38; Lumbar, 25-26; Mamma, 26; Muscles, 37-38; Neck, 22;	
Neck, Nape of, 23; Nose, 22-23; Ovarian, 31; Over Liver,	
27-28; Paroxysmal, 39-40; Pelvis, 30; Penis, 34; Pericar-	
dium, 27; Perinaeum, 33-34; Radiating, 40-41; Rectum, 34;	
Referred, 43; Regional, 18-19; Relieved by Food, 42; Re-	
lieved by Pressure, 42; Sacral, 24-25; Sharp, 39; Shifting,	
41; Shoulder, 35; Side, 27; Spinal, 23; Sternum, 26-27;	
Stomach, Pit of, 29-30; Testicle, 34-35; Thigh, 36; Throat,	
23; Umbilicus, 30	
Palate (Bone) .....	71
Palpebral Commissures .....	78
Palpebrals .....	78
Palpitating Aorta .....	66
Palpitation .....	64-65
Pancreas .....	8, 73
Calculus of, 29, 32, 40, 41; Cancer of, 27, 29, 40; Head	
of, 8, 73; Inflammation, 33, 46; Islands of Langerhans, 8,	
73; Tail of, 8, 73	
Pancreatic Disease .....	33
Pancreatic Secretions .....	82
Pancreatitis, Acute .....	29, 30
Panophtalmia .....	21
Paracusis Willisii .....	50
Paralysis—	
Agitans, 36, 38, 52, 66; Ascending, Acute, 52; Bulbar, 52,	
68; Bell's, 10; Cerebral, 12; Diphtheritic, 52, 56, 57, 59;	
External Rectus, 58; Facial, 12, 49, 52, 53, 55; General,	
20, 38, 47, 56, 57, 67; Infantile, 25, 37, 39; Klumpke's,	
57; Landouzy Dejerine, 53, 54; Oblique, Inferior, 58; Ob-	
lique, Superior, 58; Rectus, External, 58; Rectus, Inferior,	
58; Rectus, Internal, 58; Rectus, Superior, 58; Spinal, Syph-	
ilitic, 64; Sympathetic, Eye, 52, 57; Third Nerve, 52, 55, 56;	
Trigeminal, 53, 54	
Parametritis (See Perimetritis) .....	15, 34, 36, 47
Parasites .....	12, 80
Animal, 12, 80; Fruit, 12, 80; Human, 12, 80; Kidney, 25;	
Vegetable, 12, 80	
Parasitosis .....	12
Parasitosis and Ova .....	12
Parasthesiae .....	63-67
Parathyroids .....	9, 73
Parathyroid Secretions .....	82
Parenchyma, Visceral, Inflammation of .....	39
Parentage .....	80
Parietal Bones .....	71
Parotid—	
Abscess, 48; Glands, 73; Secretions, 82	
Paroxysmal Tachycardia .....	65
Pars Intermedia, Pituitary .....	80
Pectorals, Sprained .....	29

	Page
Novocain Poisoning .....	81
Numbness .....	12, 63
Arms, 12; Legs, 12	
Nymphomania .....	12
Obesity .....	15
Oblique, Inferior, Paralysis of .....	58
Oblique, Superior, Paralysis of .....	58
Obsession—	
Elemental, 12; Entity, 12; Habit, 12	
Obstruction—	
Eustachian Tube, 49, 50; Frontal Sinus, 18; Lacteal Duct, 26; Intestinal, 32; Nostrils, 61; Uterus, 16	
Obturator Hernia .....	31, 36, 42
Occipital (Bone) .....	71
Occipital Headache .....	19
Oculomotor Nerve .....	76
Oedema .....	48
Angeioneurotic, 51; Hysterical, 63; Labial, 17	
Oesophageal Angina .....	40
Oesophagismus .....	26
Oesophagus .....	80
Cancer of, 40, 41; Diverticula of, 11	
Olfactory Nerve .....	76
Omental Cancer .....	30
Omentum .....	74, 77
Oophoritis .....	15, 16, 21, 25, 30, 31, 38, 41, 42, 45, 46
Oophoritis, Adhesive .....	17
Ophthalmia .....	53
Ophthalmoplegia .....	21, 52, 55, 58
Oppression, Sensation of .....	67
Optic Atrophy .....	58
Optic Nerve .....	76, 78
Optic Nerve, Tumor of .....	56
Optic Neuritis .....	58
Orbit—	
Aneurysm of, 55; Cyst of, 55; Exostosis of, 55; Gumma of, 55; Hydatids of, 55; Tuberculous, 55; Tumor of, 53, 55, 56; Varix of, 56	
Orbital Disease .....	52
Orbital Periostitis .....	55
Orbital Plate, Fracture of .....	55
Orchitis .....	24, 35
Organic Acids .....	68
Organic Poisons .....	81
Organs .....	77-80
Female, 78-79; Male, 79-80; Prolapsus of, 13	
Os Capitatum .....	71
Os Granular .....	16
Os Hamatum .....	71
Os Lunatum .....	71
Os Multangulum, Majus .....	71
Os Multangulum, Minus .....	71
Os Naviculare .....	71
Os Pubis .....	72
Os Triquetrum .....	71
Osteitis .....	38, 43
Osteitis Deformans .....	24
Osteomalacia .....	18
Osteoma, Tibia .....	31
Osteomyelitis .....	24, 37
Otitis—	
Acute Haemorrhagic, 48; Interna, 49; Media, 19, 22, 41, 43, 44, 49; Suppurative, 48, 50; Tuberculous, 48	
Otorrhoea .....	48-49
Otomycosis .....	48
Otosclerosis .....	50
Ovarian Cyst .....	15, 32, 33, 36, 40, 65, 67
Ovarian Cyst, Double .....	15
Ovarian Disease .....	24, 26, 37, 43, 62

	Page
Pituitrin .....	57
Placenta .....	80
Platinum .....	75
Pleura .....	79
Pleura, Cancer of .....	27
Pleural Cavity .....	79
Pleural Effusion .....	56
Pleurisy.....	25, 27, 28, 35, 39, 42, 43, 45, 62
Pleurisy, Diaphragmatic.....	20, 33, 35, 43, 45, 46
Pleurodynia .....	42
Plexus—	
Cervical, 76; Hypogastric, 76; Pelvic, 76; Pulmonary, 76;	
Solar, 76	
Pneumococcal Arthritis .....	39
Pneumonia.....	21, 27, 28, 30, 33, 35, 42
Broncho, 11, 13; Toxins of, 14	
Pneumoperitonaeum .....	46
Pneumothorax .....	27, 29, 33, 39, 43
Poikilocytes .....	69
Poison .....	80-81
Ivy, 13, 81; Oak, 13, 81; Sumac, 13; to Humans, 81;	
Toxins, 81	
Poisoning—	
Arsenic, 20, 27, 29, 41, 46, 51, 59, 61, 63, 65, 80, 81; Food,	
31; Irritant, 23, 29, 32, 46, 66; Lead, 15, 16, 18, 21, 32,	
37, 38, 39, 49, 60; Phosphorus, 16, 62, 81	
Poliomyelitis, Anterior, Acute.....	18
Polycythaemia, Splenomegalic .....	21, 25, 33
Polymorphonucleárs .....	69
Polymyositis .....	23
Polypus .....	48, 62
Aural, 49, 50; Ear, 22, 48; Nose, 19, 21, 49, 50, 60, 61;	
Rectal, 31; Uterine, 16, 40, 67; Vaginal, 17, 18	
Pons, Haemorrhage into .....	57
Pons, Lesion of.....	49
Popliteal Aneurysm .....	36
Portal Vein .....	73
Post-febrile Arthritis .....	39
Post-pharyngeal Abscess.....	23, 44, 61
Potassium .....	75
Potassium Bicarbonate Poisoning .....	81
Praecordial Anxiety .....	65
Pregnancy.....	26, 36, 45, 65, 81
Embryo, 81; Female, 81; Male, 81; Tubal, 47	
Premolars .....	82
Pressure—	
Intra-cerebellar, 12, 13; Intra-cerebral, 12, 13; Intra-ocular,	
12, 13; Nerve Trunk, 63, 64	
Procrastinating .....	75
Proctitis .....	47
Prognosis, Disease .....	81
Prognosis, Patient .....	81
Progressive Muscular Atrophy.....	35, 36, 38
Prolapsus—	
Organs, 13; Ovaries, 17, 31; Uteri, 16, 17, 24, 30, 31, 46, 67	
Prostate .....	9, 73, 79
Abscess of, 33, 34, 47; Adenomatous, 33, 34; Calculus of,	
33; Cancer of, 33, 34; Tuberculous, 33, 34	
Prostatic Disease .....	37
Prostatitis .....	25, 33, 67
Proteids, Toxins of.....	14
Protein Poisoning .....	81
Psittacosis .....	37, 62
Psoas Abscess .....	36, 46
Psora .....	13
Psoriasis .....	64
Psychasthenia .....	75
Pseudangina .....	27

Cervix .....	952
Clitoris .....	79
Corpus Luteum, Right.....	333
Left.....	3331
Fallopian Tubes .....	569
Fallopian Tubes, Right.....	973
Fallopian Tubes, Left.....	972
Labia Majora .....	6101
Labia Minora .....	6103
Ovary, Right (External) .....	336
Ovary, Right (Internal) .....	338
Ovary, Left (External) .....	332
Ovary, Left (Internal) .....	334
Ovum .....	771
Uterus .....	954
Vagina .....	95
Vaginal Wall .....	92
Call Bladder .....	38
Heart .....	25
Aortic Valve .....	46
Cardiac Sac .....	2572
Endocardium .....	3795
Mitral Valve .....	2567
Pericardium .....	2587
Pulmonic Valve .....	41
Systole and Diastole.....	9033
Tricuspid Valve .....	2597
Ventricle, Right .....	256
Ventricle, Left .....	259
Intestines, Small .....	22
Duodenum .....	221
Ileum .....	223
Jejunum .....	222
Peyer's Patches .....	224
Kidneys, Right .....	37
Left .....	371
(Interstitial Tissue), Right.....	379
(Interstitial Tissue), Left.....	3719
Liver .....	48
Caudate Lobe .....	487
Falciform Ligament of Liver.....	15
Lung, Right .....	76
Left .....	77
Pleura, Right .....	7
Pleura, Left .....	71
Pleural Cavity .....	243
Male Organs	
Ductus Deferens .....	72
Epididymis .....	7405
Leydig Cells, Right.....	783
Left.....	7831
Penis .....	867
Prostate Gland .....	999
Scrotum .....	2098
Spermatic Cord .....	78

Both  
2-3

Left 784



Testicle, Right (External) .....	786
Testicle, Right (Internal) .....	788
Testicle, Left (External) .....	782
Testicle, Left (Internal) .....	781
Nipple .....	94
Nose .....	96
Stomach .....	32
Cardiac Opening .....	323
Epiglottis .....	277
Oesophagus .....	35
Pyloric Opening .....	321
Solar Plexus .....	66
Throat .....	966
Larynx .....	17
Pharynx .....	198
Tonsil, Right .....	6
Tonsil, Left .....	61
Trachea .....	8047
Uvula .....	258
Vocal Cords .....	4995
Tongue .....	1296
Ureter, Right .....	668
Left .....	6681
Urethra .....	439
<b>Parasites</b> .....	1088
Animal .....	1088103
Fruit .....	1088146
Human .....	1088119
Vegetable .....	1088126
<b>Parentage</b> .....	1414
<b>Pars Intermedia Pituitary</b> .....	695
<b>Perineum</b> .....	3568
<b>Peritoneum</b> .....	758
<b>Placenta</b> .....	9764 (or 949)
<b>Poisons</b> .....	901
Albumen .....	9019
Alcohol .....	9014004
Appetite .....	901471
Carbohydrate .....	901543
Chemicals (402 kinds) .....	901888
Chlorophyl .....	9011021
Cigarette .....	90130010
Corrosives .....	90140517
Crystals .....	901588
Drugs .....	90163
Aconite .....	901558
—Arsenic .....	901656
Bella Donna .....	901448
Camphor .....	90180741
Contharides .....	9011026
Cocaine .....	901206

WORM - - - 80 - - - 9080  
Salt Peter 901786

	Page
Pterygium .....	13
Ptomainism .....	33, 57
Ptosis, Congenita .....	52
Pudic Neuritis .....	17
Pulmonary Abscess .....	41
Pulmonary Arteries .....	72
Pulmonary Embolism .....	29
Pulmonary Plexus .....	76
Pulmonary Thrombosis .....	30
Pulmonary Artery Thrombosis .....	27
Pulmonary Veins .....	73
Pulmonic Valve .....	79
Punctum Displaced .....	54
Punctum Lacrimalis .....	78
Pulp, Abscess of .....	22
Pulpitis, Dental .....	22, 40
Pupils, Eye, Contracted .....	57
Pupils, Eye, Dilated .....	56-57
Purpura .....	16
Henoch's, 31, 32, 40; Haemorrhagica, 51, 63	
Pus—	
Teeth, 13; Corpuscles, 83; Malignant, 13	
Pyæmia .....	39
Pyelitis .....	25, 30
Pyloric Opening, Stomach .....	80
Pyloric Stenosis .....	32
Pyloric Ulcer .....	40
Pylorus, Cancer of .....	27, 29
Pyodermatitis Vegetans .....	64
Pyometra .....	16
Pyonephrosis .....	25
Pyorrhoea .....	13
Pyrexia .....	21
Quinsy .....	23
Rabies .....	13
Radial Nerve .....	76
Radium .....	75
Radium Burn .....	13
Radius .....	71
Ranula .....	13
Rashes, Drug .....	64
Raynaud's Disease .....	58, 60
Ear, 48; Skin, 36; Toes, 37	
Receding Gums .....	11, 13
Recklinghausen's Disease .....	39, 44, 63
Rectal Muscle .....	75
Rectal Muscle, Strain of .....	30
Recti, Divarication of .....	30
Recto-vaginal Fistula .....	18
Rectum .....	77
Abscess of, 25; Cancer of, 24, 31, 33, 34, 36, 38, 41, 66, 67;	
Foreign Body in, 34; Neuralgia of, 34; Pain in, 34; Polypus	
of, 31; Ulcer of, 33, 34, 67	
Rectus—	
Inferior, Paralysis of, 58; Internal, Paralysis of, 58; External,	
Paralysis of, 58; Superior, Paralysis of, 58	
Red Blood Corpuscles .....	83
Remedies, Preparation of .....	6
Renal Calculus .....	25, 31, 32, 34, 36, 37, 40, 41, 42, 43, 44, 46
Renal Cancer .....	44
Renal Colic .....	28, 34, 43
Renal Embolism .....	25
Renal Infarct .....	44
Renal Insufficiency .....	15
Renal Thrombosis .....	26
Retina .....	78
Retina, Fatigue of .....	59
Retinitis .....	57, 59

	Page
Retrobulbar Haemorrhage .....	56
Retroflexion, Uterus.....	16, 26, 31, 46
Retromammary Abscess .....	26
Retroversion.....	16, 24, 30, 67
Rheumatic Fever .....	33, 37
Rheumatism—	
Acute, 42; Chronic, 39; Intercostal, 27, 43, 45; Intestinal,	
32; Muscular, 16, 18, 19, 21, 23, 24, 26, 29, 33, 35, 36, 37,	
38, 39, 41, 42, 43, 44; Nerves, 15; Temporomaxillary, 22	
Rheumatoid Arthritis.....	36, 39, 42, 44, 49, 55, 58
Rhinitis, Tuberculous .....	62
Rhinorrhoea .....	61-63
Rhinorrhoea, Watery or Mucous.....	61
Rib .....	72
Cartilage, 76; Caries of, 27; Cervical, 35, 41, 63, 64; Float-	
ing, 31; Fractured, 27, 42, 43	
Rider's Sprain .....	31
Ringworm .....	13
Rodent Ulcer, Cornea.....	53
Rodent Ulcer, Ear.....	48
Rupture—	
Aortic Cusp, 27; Membrane Ear, 49; Muscle, 38, 42; Tym-	
panum, 49	
Sac, Abscess of .....	54, 55
Sacral Glands Enlarged .....	36
Sacral Pain .....	24-25
Sacral Vertebrae .....	72
Sacro-coccygeal Tuberculosis .....	24
Sacro-iliac Disease.....	24, 46, 47
Salivary Calculus .....	22
Salivary Glands .....	73
Salivary Secretions .....	82
Salpingitis.....	16, 17, 24, 30, 31, 34, 42, 47
Saphenous Varix .....	31
Sarcoma .....	62
Ear, 48; Femur, 36; Innominate, 36; Liver, 45; Nose, 63;	
Scrotum, 35; Uterus, 16, 17, 24	
Scabies .....	64
Scalp .....	81
Scalp Tenderness .....	43
Scapula .....	72
Scarlatina .....	15, 23, 62, 63
Scarlet Fever .....	13
Scar Tissue .....	13
Scars, Contraction of .....	53
Sciatica .....	36, 37, 42, 63, 64
Scirrhus Cancer .....	11
Sclerodermia .....	44, 55
Sclerosis—	
Amyotrophic Lateral, 35; Arterio, 50, 53, 62, 64, 68; Dis-	
seminated, 20, 40, 58, 63, 64, 65; Disseminated, Spine, 23;	
Multiple, 12	
Scotoma .....	58
Scrotum .....	79
Scrotum, Sarcoma of .....	35
Scurvy.....	16, 18, 37, 39, 51, 56, 58, 63
Scurvy, Infantile .....	18, 36, 51, 55, 62
Scybala .....	24, 32, 40
Sebaceous Cyst .....	30
Sebaceous Cyst, Ear .....	48
Sebaceous Cyst, Suppurating .....	49
Seborrhoea .....	44, 64
Secretions .....	82
Self-esteem .....	75
Selfishness .....	75
Self-pity .....	75
Sella Turcica .....	71

	Page
Semi-circular Canal .....	78
Semilunar Cartilage .....	76
Seminal Vesiculitis .....	33, 34
Senility .....	53, 75
Sensation .....	63-67
Sensory Nerves .....	76
Sensory Nervous System.....	77
Sepsis, Gums .....	39
Septicaemia .....	37
Septic Endometritis.....	17, 18, 30
Septum—	
Abscess of, 61; Deviate, 55; Haematoma of, 61; Spur, 21, 60, 61	
Serofibrinous Tumor .....	14
Serums, Toxins of.....	14
Sex .....	82
Sex Centers .....	82
Shock .....	49
Shoulder Joints .....	72
Shoulder, Pain in.....	35
Shoulders .....	82
Shreds and Membranes.....	18
Side, Pain in.....	27
Sight .....	78
Sigmoid .....	77
Sigmoid, Loaded .....	31
Sigmoiditis .....	31, 47
Silicon .....	75
Silver .....	75
Sinking Feeling .....	65
Sinuses .....	82
Cavernous, Thrombosis of, 51, 56; Frontal, Distension of, 51, 55; Frontal, Empyema of, 61; Obstruction of, 18; Lateral, Thrombosis of, 44, 49; Long., Thrombosis of, 51; Sup. Long., Thrombosis of, 19, 56	
Sinusitis .....	61
Sinusitis, Sphenoidal .....	21, 22, 56
Skin .....	82
Skin, Raynaud's Disease of.....	36
Skull .....	71
Small-pox, Toxins of.....	14
Snake Poisoning .....	81
Sneezing.....	13, 60, 82
Sodium .....	75
Sodium Poisoning .....	81
Sodium Bicarbonate Poisoning.....	81
Softening—	
Brain, 21, 60; Chronic, 38; Spine, 63	
Solar Plexus .....	76, 80, 82
Somnolent .....	75
Sparks Before Eyes.....	58
Specific Gravity, Urinalysis.....	83
Spermatic Cord .....	79
Spermatozoa .....	83
Spermatozoan Secretions .....	82
Sphenoid .....	71
Sphenoidal Disease .....	19
Sphenoidal Sinusitis .....	21, 22, 56
Sphincter Muscles .....	75
Spider Bite .....	13
Spinal Abscess .....	31
Spinal Accessory Nerve.....	76
Spinal Apoplexy.....	23, 24, 27, 38, 44, 63, 64
Spinal Column, Sprain of.....	42
Spinal Cord.....	77, 78, 82
Spinal Meningeal Haemorrhage.....	23, 24, 39, 41, 64
Spinal Meningitis.....	18, 21, 33, 36, 37, 38, 40, 41, 42, 44, 64
Spinal Meningitis, Internal.....	24, 25, 41
Spinal Meningitis, Syphilitic.....	66
Spinal Pachymeningitis, External.....	23, 25, 41, 42

	Page
Spinal Pain .....	23-24
Spinal Paralysis, Syphilitic.....	64
Spinal Periostitis .....	44
Spinal Tumor .....	33, 36, 41, 42, 44, 63, 64
Spine—	
Cancer of, 23, 25, 44; Caries of, 25, 26, 27, 29, 30, 32, 37,	
41, 42, 43, 44; Fracture of, 27; Hyperaemia of, 23, 63, 64;	
Softening of, Chronic, 63; Tenderness in, 44; Thrombosis	
of, 63; Typhoid of, 26, 44	
Spitefulness .....	75
Spleen .....	9, 73
Abscess of, 46; Affections of, 41; Anaemia of, 45; Cancer	
of, 46; Enlarged, 28; Infarct, 28, 46	
Splenic Flexure .....	77
Splenic Secretions .....	82
Spleno-medullary Leukaemia .....	46
Spondylitis, Traumatic .....	24, 42, 44, 66
Spondylose Rhizomelique .....	44
Sprain .....	28, 37, 42
Muscles, 23; Pectorals, 29; Spinal Column, 42; Spinal	
Cord, 24	
Spur, Septum .....	21, 60, 61
Stammering .....	75
Stapes .....	78
Staphylococcus .....	13
Stellwag's Sign .....	53
Stenosis—	
Aorta, 10; Canal, 16; Mitral, 57, 62; Pyloric, 32	
Sternal Periostitis .....	45
Sterna Clavicle Joints.....	72
Sternum .....	72
Caries of, 26, 43, 45; Pain in, 26-28	
Stimulation, Sympathetic Nerves.....	53
Stomach .....	80
Atony of, 20, 26, 28, 29, 35, 40, 65, 66, 67; Cancer of, 25,	
26, 27, 28, 29, 41, 46, 65; Cirrhosis of, 26, 29, 46; Dilata-	
tion of, 20, 29, 65, 66, 67; Gout of, 29; Perforation of 43;	
Pit of, Pain in, 29-30; Ulcer of, 15, 24, 28, 30, 41, 43, 44,	
46, 65	
Stone, Gall-bladder.....	13, 28, 29, 30, 31, 32, 45, 46
Stone, Ureter .....	34
Strain .....	23, 28
Eye, 18, 19, 21, 51; Eye, Unilateral, 19; Heart, 27, 45;	
Recti Muscle, 30	
Strangulated Hernia .....	12, 32
Streptococcus .....	13
Streptococcus Toxins .....	14
Stricture .....	34
Stye .....	51, 52, 53
Subclavian Aneurysm .....	35
Subconjunctival Fat .....	54
Subinvolution.....	16, 25, 30, 67
Sub-lingual Secretion .....	82
Sub-maxillary Secretion .....	82
Subphrenic Abscess.....	27, 28, 29, 32, 43, 44
Sugar .....	83
Sugar, White, Toxins of.....	14
Sulphur .....	75
Sunstroke.....	21, 56, 57
Superinvolution .....	15
Suppuration, Middle Ear.....	49
Suppression, Menses .....	60
Suprarenal Capsule, Tumor of.....	35
Suprarenals .....	8, 74
Sweating, Sensation of.....	66
Swelling .....	13
Ear, 47-48; Lid, 51-52; Meatus, 48; Nose, 60; Localized, 52	
Sycosis, Tarsi .....	53
Sympathetic Nerve Stimulation.....	53
Sympathetic Nerves .....	76

	Page
Sympathetic, Paralysis of, Eye.....	52, 57
Syncope .....	57
Synovial Membranes .....	74
Synovitis .....	35, 39, 42
Synovitis, Tubercular .....	40
Syphilis .....	18, 19, 21, 23, 27, 37, 38, 39, 43, 49, 60
Congenital, 44; Congenital, Cornea, 53; Heart, 27, 40, 65;	
Hereditary, 62; Labyrinthine, 50; Liver, 28, 45, 67; Mexican,	
13; Nose, 60, 61; Tertiary, 62; Uterus, 16	
Syphilitic Nodes .....	19
Syphilitic Periostitis .....	29, 44
Syphilitic Spinal Meningitis.....	66
Syphilitic Paralysis .....	64
Syringomyelia .....	19, 23, 24, 36, 39, 52, 57, 58, 59, 63, 64, 66
Systole and Diastole.....	79
Tabes Mesenterica .....	33
Tachycardia, Paroxysmal .....	65
Talipes Valgus .....	31
Talus .....	71
Tape Worm .....	21, 41, 50
Tarsal Glands .....	78
Tears, Overflowing .....	54
Technic, Homo-Vibra Ray Instrument.....	1-7
Technic, Urinalysis .....	4
Teeth .....	82
Teeth, Caries of .....	19
Telangiectasis .....	63
Temperature .....	4, 83
Temporal Bone .....	71
Caries of, 22, 48, 52; Necrosis of, 48	
Temporomaxillary Rheumatism .....	22
Tenderness .....	43-47
Abdominal, 46-47; Breast, 45; Chest, 45; Epigastrium, 46;	
Hypochondrium, 45-46; Hypogastrium, 47; Iliac, 46-47;	
Liver, 46; Lumbar, 44; Perinaeum, 47; Scalp, 43-44; Spine,	
44	
Tendon .....	76
Tenia .....	13
Tenonitis .....	51, 56
Teno-synovitis .....	36
Tension, High Arterial.....	21
Testicles.....	9, 34, 74, 80
Cancer of, 24, 34; Injuries to, 35; Pain in, 34-35; Peri-	
naeal, 33; Tuberculosis of, 35	
Testicular Cysts .....	31
Tetanus (See Tetany).....	23, 38, 52
Tetany (See Tetanus).....	63, 64
Thigh .....	83
Thigh, Pain in.....	36
Thoracic Aneurysm.....	26, 64, 67
Thoracic, Descending, Aneurysm of.....	41
Thoracic Duct .....	73
Throat .....	80
Cancer of, 23; Foreign Body in, 23; Pain in, 23	
Throbbing, Sensation of.....	66
Thrombosis .....	38, 64
Cavernous Sinus, 51, 56; Cerebral, 21, 50, 51, 57, 59; Eye-	
ball, 55; Lateral Sinus, 44, 49; Long. Sinus, 51; Mesenteric	
33; Pulmonary, 30; Pulmonary Artery, 27; Renal, 26; Splne,	
63; Sup. Long. Sinus, 19, 56	
Thrombus .....	13
Thumbs, Bones of.....	71
Thymus .....	74
Thymus, Enlarged .....	56, 63
Thyroid .....	9, 74
Thyroid Extract Poisoning.....	81
Thyroxin .....	82
Tibia .....	71
Old Fracture of, 31; Osteoma of, 31	

	Page
Tic-douloureux .....	40
Tin .....	75
Tinea Tarsi .....	53
Tingling .....	63
Tinnitus Aurium .....	50
Tissue .....	83
Tissue, Colloidal .....	73
Tobacco .....	57
Tobacco, Abuse of .....	60
Toe Joints .....	72
Toes .....	83
Bones of, 71; Raynaud's Disease of, 37; Trauma of, 37	
Tongue .....	80, 83
Cancer of, 19, 22; Lesions, Basal, 19; Mucus, 82; Ulcer of, 22	
Tonsillitis .....	23
Tonsillitis, Follicular .....	38
Tonsils .....	80
Concretions of, 23; Tuberculous, 23	
Tophi .....	47
Couty, 52; Inflamed, 48	
Toxaemia .....	22
Toxins—	
All Diseases, 13; Alcohol, 13; Anger, 13; Brain, 13; Candy,	
13; Carbohydrates, 13; Carcinoma, 11, 13; -Chickenpox, 13;	
Destroyed, 13; Diphtheria, 13; Fatigue, 13; Fats, 13; Food,	
13; Hate, 13; Influenza, 13; Lesion, 13; Lues, Congenital,	
13; Malaria, 13; Measles, 13; German Measles, 13; Mumps,	
13; Pertussis, 13; Pneumonia, 14; Proteids, 14; Serums, 14;	
Small-pox, 14; Streptococcus, 14; Sugar, White, 14; Typhoid,	
14; Vaccine, 14; Venereal, 14	
Trachea .....	80
Trachoma .....	51, 52
Trachoma, Old .....	52
Trachomatous Ulcer, Cornea .....	54
Transverse Colon .....	77
Trauma .....	44, 47, 83
Ear, 48; Hand, 36; Meatus, 49; Toes, 37	
Traumatic Neurasthenia .....	35, 44, 64
Traumatic Spondylitis .....	24, 42, 44, 66
Trench Mouth .....	14
Trichinosis .....	18, 38, 41, 43, 51, 59, 67
Tricuspid Valve .....	79
Trigeminal Neuralgia .....	19, 21, 22, 44, 52, 54, 59, 61
Trigeminal Paralysis .....	53, 54
Trigeminus .....	76
Trochlear Nerve .....	76
Tubal Colic .....	17, 30, 40
Tubal Foetation .....	30
Tubal Gestation .....	47
Tubal Pregnancy .....	47
Tube Casts .....	83
Tubercle—	
Bladder, 30, 33, 34; Caecum, 47; Hand, 36; Nose, 61, 63	
Tubercular Synovitis .....	40
Tuberculosis—	
Acquired, 14; After Vaccination, 14; Animal Parasite, 14;	
Avian 14; Bone, 37, 38; Complicating Hay Fever, 14; Cor-	
nea, 53; Cryptogenic, 14; From Cows' Milk, 14; From	
Pollen, 14; Fruit, 14; Inherited, 14; Kidney, 15, 25, 32;	
Joint, 39, 42, 43; Meatus, 49; Orbit, 55; Prostate, 33, 34;	
Testis, 35; Uterus, 16; Vegetable, 14	
Tuberculous Abscess .....	26
Tuberculous Discharge, Eye .....	55
Tuberculous Meningitis .....	24, 25, 38, 52, 56, 57
Tuberculous Pharyngitis .....	23
Tuberculous Rhinitis .....	62
Tuberculous Synovitis .....	40
Tuberculous, Tonsillitis .....	23
Tuberculous Ulcer, Cornea .....	54

	Page
Tularemia .....	14
Tumefaction .....	14
Tumor—	
Abdominal, 26, 34, 36, 38, 65; Antrum, 56; Benign, 10;	
Brain, 21, 50, 56, 58, 59, 60, 64; Cauda Equina, 25, 38;	
Cerebellar, 26, 41; Cerebral, 19, 40, 43, 59; Colon, 34;	
Cord, 24, 26, 30, 66; Cranial, 42; Crus, 52; Eyelid, 52; Intra-	
cranial, 42; Labyrinth, 49; Mediastinum, 26, 29, 35, 44, 67;	
Neck, 56, 57, 63; Optic Nerve, 56; Orbit, 53, 55, 56; Pel-	
vic, 36, 67; Serofibrinous, 14; Spinal, 33, 36, 41, 42, 44,	
63, 64; Suprarenal Capsule, 35; Uterus, 25	
Turbinate, Middle, Cyst of.....	61
Turbinated Bone, Enlarged.....	21, 61
Twelfth Dorsal Nerve, Neuralgia of.....	31, 46
Typhoid Spine .....	26, 44
Typhoid, Toxins of.....	14
Typhus.....	10, 21, 49, 50, 54, 57, 59, 61
Typhus, Malignant .....	51
Tympani .....	78
Tympanites .....	65, 66
Tympanum, Ruptured .....	49
Ulcer .....	14
Bladder, 30, 34, 47; Catarrhal, 53; Cornea, 53, 59; Dip-	
therial, Eye, 53; Duodenum, 28, 30, 35, 41, 42, 44, 65;	
Gastric 26, 30; Gonorrhoeal, Eye, 53; Herpetic, Eye, 53;	
Intestine, 33; Larynx, 22; Nose, 62, 63; Pharynx, 80; Phlyc-	
tenular, Eye, 53; Pyloric, 40; Rectum, 33, 34, 67; Rodent,	
Cornea, 53; Rodent, Ear, 48; Stomach, 15, 24, 28, 30, 41;	
43, 44, 46, 65; Tongue, 22; Trachomatous; Cornea, 54;	
Tuberculous, Cornea, 54	
Ulcerated Teeth .....	14
Ulna .....	71
Ulnar Nerve .....	76
Ulnar Motive .....	75
Umbilical Hernia .....	31
Umbilicus, Pain in.....	30
Uraemia .....	19, 21, 49, 57, 60
Uranium .....	75
Urates .....	83
Urea .....	83
Ureter, Clot in .....	40
Ureter, Stone in .....	34
Ureteral Calculus .....	31, 32, 34, 40, 46
Ureters .....	80
Urethra .....	80
Urethral Abscess .....	47
Urethral Calculus .....	39, 40
Urethral Caruncle .....	11, 14
Urethral Granulations .....	34
Urethral Muscle .....	75
Urethritis .....	17
Uric Acid .....	14, 68
Uric Acid Crystals .....	83
Urinalysis .....	4, 83
Urticaria .....	38, 51, 64
Uterine Atrophy .....	15
Uterine Congestion .....	15, 16, 47, 67
Uterine Diseases .....	19, 24, 34, 64
Uterine Displacement .....	36
Uterus .....	8, 74, 79
Cancer of, 16, 17, 18, 24, 30, 31, 34, 38, 40, 46; Fibroid	
of, 15, 24, 30, 32, 40, 41, 67; Flexions of, 24; Hypertrophy	
of, 15, 16, 30; Inversion of, 16, 24, 30, 67; Neuralgia of,	
30; Obstruction in, 16; Polypus of, 16, 40, 67; Prolapsus	
of, 16, 17, 24, 30, 31, 46, 67; Retroflexion of, 16, 26, 31,	
46; Sarcoma of, 16, 17, 24; Syphilis of, 16; Tuberculosis of,	
16; Tumor of, 25	
Uvula .....	80
Uvula, Swollen .....	23



	Page
Vaccine, Toxins of	14
Vacillating	75
Vagina	79
Vaginal Discharge	17-18
Vaginal Epithelioma	33
Vaginal Fibroid	17
Vaginal Muscle	75
Vaginal Polypus	17, 18
Vaginal Wall	79
Vaginismus	17
Vaginitis, Acute	34
Vaginitis, Catarrhal	17
Vaginitis, Senile Granular	17
Vagus Nerve	76
Valve—	
Aortic, 79; Ileo-cecal, 77; Mitral, 79; Pulmonic, 79; Tri-	
cuspid, 79	
Valvular Disease	21, 27, 36, 65
Varicocele	31, 35
Varicose Veins	14
Varicosities, Nose	63
Variola	21, 26, 51, 61, 64
Variola, Malignant	17, 51
Varix, Orbit	56
Veins	73
Vena Cava, Inferior	73
Vena Cava, Superior	73
Venereal Toxins	14
Ventral Hernia	12, 25
Ventricle, Right, Dilated	29, 46, 65
Ventricles	79
Vertebrae—	
Bones, 72; Caries of, 23; Joints, 72	
Vertigo	68
Vesical Calculus	25, 33, 34, 36, 40, 41, 43, 47
Vesiculitis, Seminal	33, 34
Visceral Inflammation	37
Visceral Parenchyma, Inflammation of	39
Vision	57-60, 78
Vitality	83
Vitamin	83
Vitamin Poisoning	81
Vocal Cords	80
Voluntary Muscle	76
Vomiting	51, 56
Vulvitis	17
Warts	14, 52
Water Poisoning	81
Wax, Ears	11, 78
Wax, Meatus	19, 49, 50
Waxy Ears	47
Weight, Sensation of	66
Weil's Disease	21, 38, 43, 45
Whiskey Poisoning	81
White Kidneys	12
Whooping Cough	51, 54, 59, 60, 61, 63
Wisdom Teeth	82
Worms	14, 17, 61, 63, 64
Animal, 14; Fluke, 14; Pin, 14	<i>Tape 21, 41, 50</i>
Worry	75
Wrist Joints	72
Xanthelasma	52
X-Ray Burn	14
Yellow Atrophy, Acute	17, 28, 29, 45, 46, 56, 63
Zinc	75

	Page
Efferent Nerves .....	76
Elbow .....	71
Elbow Joints .....	72
Emboli .....	63, 64
Embolism—	
Brain, 60; Cerebral, 20; Pulmonary, 29; Renal, 25; Sup. Mesenteric Artery, 32	
Embryoma .....	35
Emphysema, Atrophic .....	10
Emphysema, Lung .....	28, 62, 66, 67
Empyema—	
Antrum, 59, 61; Frontal, 22; Frontal Sinus, 61; Gall-bladder, 28, 45; Necessitatis, 45	
Encephalitis .....	20, 59, 64
Encephalocele .....	55
Encephaloid Cancer .....	55
Endocarditis .....	27, 66
Endocarditis, Infective .....	51
Endocardium .....	79
Endocrine Glands .....	8-9, 73
Endometritis .....	15, 16, 24
Chronic, 17, 18, 30; Gonorrhoeal, 30; Haemorrhagic, 17, 30; Hypertrophic, 67; Purulent, 17; Senile, 17, 18; Septic, 17, 18, 30	
Enlargement—	
Hepatic, 66; Spleen, 28; Thymus, 56, 63; Turbinated Bone, 21, 61	
Ensiform Cartilages .....	76
Enteric Fever .....	15, 18, 37, 45, 49, 50, 62
Enteritis .....	32
Enteroptosis .....	25, 29, 31, 32, 67
Enteropasm .....	32
Eosinophils .....	70
Epididymis .....	79
Epididymis, Nodules in .....	35
Epididymitis .....	35
Epigastric Hernia, Small .....	29
Epigastrium, Pain in .....	29-30
Epigastrium, Tenderness in .....	46
Epiglottis .....	80
Epilepsy .....	19, 20, 27, 47, 52, 55, 56, 58, 59, 60, 65
Epithelial Cells .....	83
Epithelioma .....	52
Ear, 48; Meatus, 48; Vagina, 33	
Ergotin Poisoning .....	81
Erichsen's Sign .....	47
Erosion, Meatus .....	48
Erosions, Cervical .....	17, 31, 46
Erysipelas .....	20, 43, 48, 51, 60, 62
Erythrocytes .....	69
Erythromelalgia .....	38, 40, 43
Ethmoid—	
Bone, 71; Caries of, 61; Cells, Dilated, 55; Sinus, 82	
Eustachian Obstruction .....	49, 50
Eustachian Tube .....	78
Exophthalmic Goitre .....	15, 16, 20, 51, 52, 53, 54, 55, 62, 65, 66
Exophthalmos, Pulsating .....	50
Exostosis .....	38, 61
Dental, Upper Jaw, 22; Dental, Lower Jaw, 22; Meatus, 48; Orbit, 55	
External Spinal Pachymeningitis .....	23, 25, 41, 42
Eye .....	51-60, 78
Carcinoma of, 55; Congenital Defect, 58; Diphtherial Ulcer of, 53; Flashes Before, 58; Gonorrhoeal Discharge, 55; Gonorrhoeal Ulcer of, 53; Injuries to, 51; Irritants to, 54; Open Continuously, 53; Pupils of, 56-57; Sclerotic, 54; Sclerotic, Pearly, 54; Sclerotic, Yellow, 54; Simple Dis- charge of, 55; Strain, 18, 19, 21, 51; Tuberculous Discharge of, 55	

	Page
Eyeballs	21
Fixed, 55; Pain in, 21; Thrombosis of, 55	
Eyelids	51-53, 78
Cyst of, 51; Darkened, 51-52; Drooping, 52; Echymosed, 51; Edges Crusted, 53; Glanders of, 51; Swollen, 51-52; Tumor of, 52	
Eye Teeth	82
Face	73
Facial Hemiatrophy	52
Facial Nerve	76
Facial Paralysis	12, 49, 52, 53, 55
Faecal Accumulation	25, 27, 28, 32, 42, 46, 64, 67
Faecal Impaction	34, 36, 46
Falciform Ligament, Liver	79
Fallopian Tubes	79
Fascia	73, 76
Fascia, Contraction of	11
Fat Poisoning	87
Fat, Subconjunctival	54
Fat Toxins	13
Fatigue	25, 51
Fatigue, Mental, 11, 74; Retina, 59; Toxins, 13	
Fatty Degeneration of Liver	45
Fatty Heart	53, 65, 66
Fear	11, 74
Felon	11
Female Organs	78-79
Female Sex	82
Femoral Aneurysm	36
Femoral Hernia	12
Femoral Periostitis	36
Femur	71
Femur, Sarcoma of	36
Ferrum Poisoning	81
Fever	18, 38
Enteric, 15, 18, 37, 45, 46, 49, 50, 62; Hay, 20, 49, 51, 54, 60, 61; Articular, 10; Bilious, 10; Glandular, 20, 22, 32, 42; Rheumatic, 33, 37; Scarlet, 13; Typhus, 10, 21, 49, 50, 51, 54, 57, 59, 61	
Fibrin Poisoning	81
Fibroids (See Fibroma)	15, 16
Cervix, 18; Heart, 27, 65; Uterine, 15, 24, 30, 32, 40, 41, 67; Vaginal, 17	
Fibroma (See Fibroids)	11
Fibroma, Nose	62
Fibrositis	35, 36, 39, 42
Fibrositis, Intestinal	37
Fibula	71
Fifth Nerve, Neuralgia of	21
Fingers	73
Bones of, 71; Joints of, 72	
Fissure, Anus	17, 24, 33, 34
Fistel Symptom	50
Fistula	24, 33, 34
Labyrinthine, 50; Recto-vaginal, 18	
Fistula, Recto-vaginal	18
Fistulous Auricles	47
Flatulence	25, 26, 27, 41, 65, 67
Flea Bite	11
Flexions of Uterus	24
Flexure, Hepatic	77
Flexure, Splenic	77
Floating Kidneys	25, 28, 38, 40
Floating Rib	31
Fluid (Anywhere)	11
Foetus, Death of	18
Food Poisoning	31
Food Toxins	13
Foot	73
Bones of, 71; Pain in, 37	